



AKD5700-A

AK5700 Evaluation board Rev.0

GENERAL DESCRIPTION

AKD5700-A is an evaluation board for the portable digital audio 16bit A/D converter, AK5700. AKD5700-A also has the digital audio interface and can achieve the interface with digital audio systems via opt-connector.

■ **Ordering guide**

AKD5700-A --- Evaluation board for AK5700
 (Cable for connecting with printer port of IBM-AT compatible PC and control software are packed with this. This control software does not support Windows NT.)

FUNCTION

- **DIT with optical output**
- **RCA connector for an external clock input**
- **10pin Header for serial control interface**

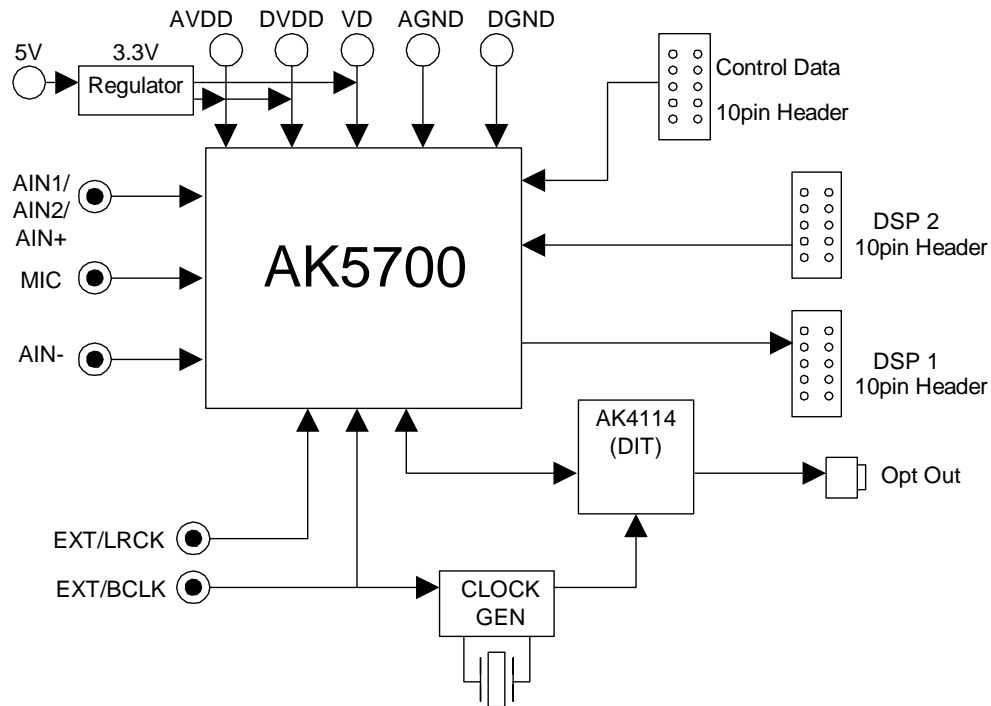

Figure 1. AKD5700-A Block Diagram

* Circuit diagram and PCB layout are attached at the end of this manual.

Evaluation Board Manual

■ Operation sequence

1) Set up the power supply lines.

1-1) When AVDD, DVDD and VD are supplied from the regulator.

[REG]	(Red)	= 5V	
[AVDD]	(Orange)	= open	
[DVDD]	(Orange)	= open	
[VD]	(Orange)	= 2.7 ~ 3.6V	: for logic
[AGND]	(Black)	= 0V	: for analog ground
[DGND]	(Black)	= 0V	: for logic ground

1-2) When AVDD, DVDD and VD are not supplied from the regulator.

[REG]	(Red)	= "REG" jack should be open.	
[AVDD]	(Orange)	= 2.4 ~ 3.6V	: for AVDD of AK5700 (typ. 3.0V)
[DVDD]	(Orange)	= 1.6 ~ 3.6V	: for DVDD of AK5700 (typ. 3.0V)
[VD]	(Orange)	= 2.7 ~ 3.6V	: for logic
[AGND]	(Black)	= 0V	: for analog ground
[DGND]	(Black)	= 0V	: for logic ground

Each supply line should be distributed from the power supply unit.

2) Set up the evaluation mode, jumper pins and DIP switches. (See the followings.)

3) Power on.

The AK5700 and AK4114 should be reset once by bringing SW1, 2 "L" upon power-up.

■ Evaluation mode

In case of AK5700 evaluation using AK4114, same audio interface format should be set for both AK5700 and AK4114. About AK5700's audio interface format, refer to datasheet of AK5700. About AK4114's audio interface format, refer to Table 2 in this manual.

Applicable Evaluation Mode

- (1) Evaluation of PLL, Master Mode (Default)
- (2) Evaluation of PLL, Slave Mode (PLL Reference CLOCK: MCKI pin)
- (3) Evaluation of PLL, Slave Mode (PLL Reference CLOCK: BCLK or LRCK pin)
- (4) Evaluation of using DIT of AK4114 (opt-connector): EXT, Slave Mode
- (5) Slave & Bypass Mode
- (6) Bypass Mode

(1) Evaluation of PLL, Master Mode (Default)

***Connect PORT2 (DSP1) with DSP.**

Figure below shows PORT2 pin assign.

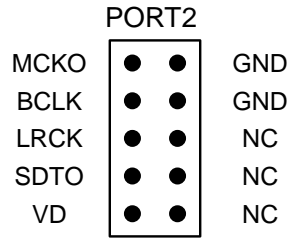

a) Set up jumper pins of MCKI clock

When using X'tal as MCKI clock, X'tal of 11.2896MHz, 12MHz, 12.288MHz, 13MHz, 24MHz or 27MHz can be set to X1. X'tal of 11.2896MHz (Default) is set on the AKD5700-A.

When an external clock (11.2896MHz, 12MHz, 12.288MHz, 13MHz, 24MHz or 27MHz) is supplied through an RCA connector (J3: EXT/BCLK), select EXTCLK/BCLK on JP16 (XTI) and select EXTCLK/BCLK on JP19 (MCLK_SEL). JP14 (EXT1) and R20 should be properly selected in order to match the output impedance of the clock generator.

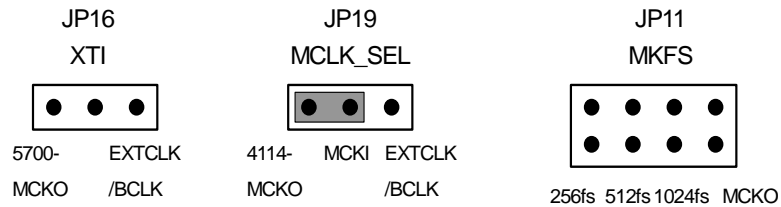

b) Set up jumper pins of BCLK clock

Output frequency (32fs/64fs) of BCLK should be set by "BCKO1-0 bit" in the AK5700. There is no necessity for set up JP12.

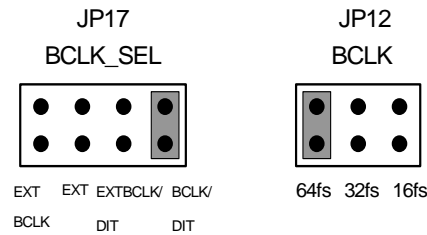

c) Set up jumper pins of LRCK clock

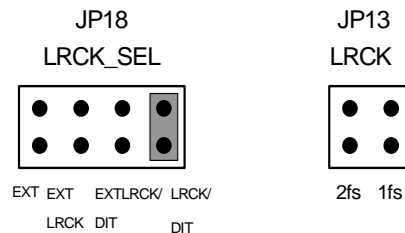

(2) Evaluation of PLL, Slave Mode (PLL Reference CLOCK: MCKI pin)

***Connect PORT4 (DSP2) with DSP.**

Figure below shows PORT4 pin assign.

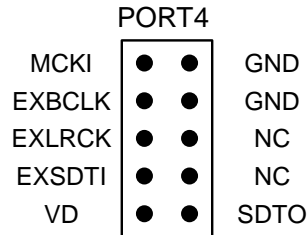

a) Set up jumper pins of MCKI clock

X'tal of 11.2896MHz (Default) is set on the AKD5700-A. In this case, the AK5700 corresponds to PLL reference clock of 11.2896MHz. In this evaluation mode, the output clock from MCKO pin of the AK5700 is supplied to a divider (U3: 74VHC4040), EXBCLK and LRCK clocks are generated by the divider. Then "MCKO bit" in the AK5700 should be set to "1".

When an external clock is supplied through an RCA connector (J3: EXT/BCLK), select EXTCLK/BCLK on JP16 (XTI) and select EXTCLK/BCLK on JP17 (MCLK_SEL). JP14 (EXT1) and R20 should be properly selected in order too match the output impedance of the clock generator.

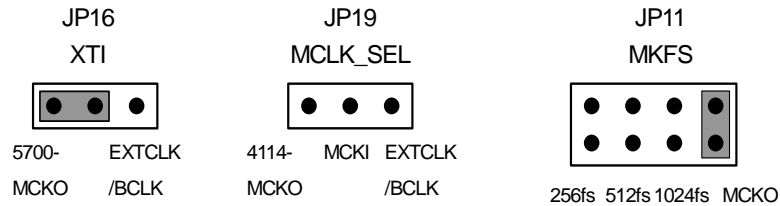

b) Set up jumper pins of BCLK clock

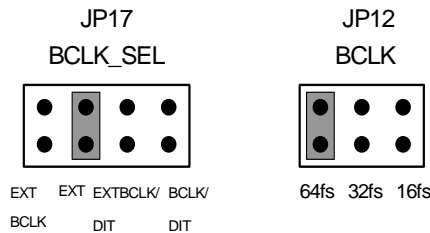

c) Set up jumper pins of LRCK clock

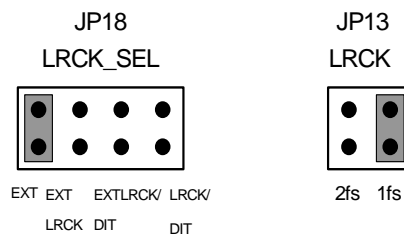

(2-a) In the case of using AK4114.

*This mode is BCLK=64fs, LRCK=1fs only.

Set up jumper pins of MCKI clock

*In the case of using X1, JP16 should be open.

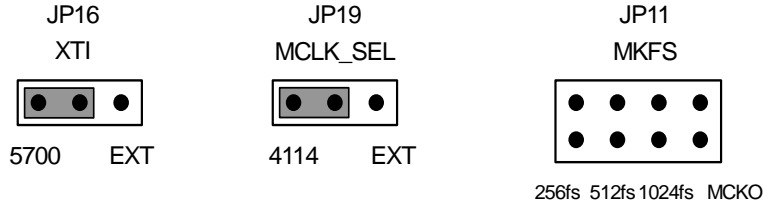

Set up jumper pins of BCLK clock

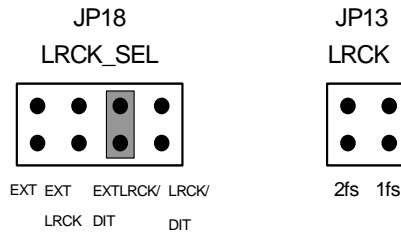

Set up jumper pins of LRCK clock

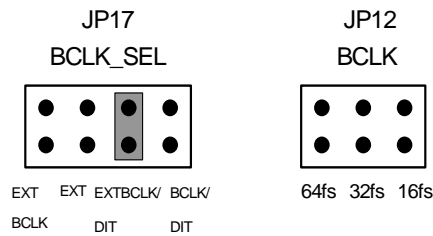

(3) Evaluation of PLL, Slave Mode (PLL Reference CLOCK; BCLK or LRCK pin)

***Connect PORT4 (DSP2) with DSP.**

Figure below shows PORT4 pin assign

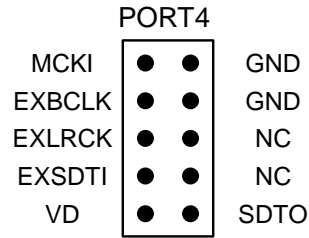

a) Set up jumper pins of MCKI clock

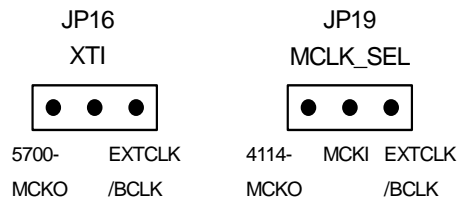

b) Set up jumper pins of BCLK clock

When an external clock is supplied through a RCA connector J3 (EXT/BCLK), J4 (EXT/LRCK), JP14 (EXT1) and R20, JP15 (EXT2) and R21 should be properly selected in order to match the output impedance of the clock generator.

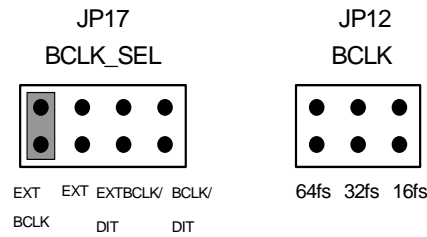

c) Set up jumper pins of LRCK clock

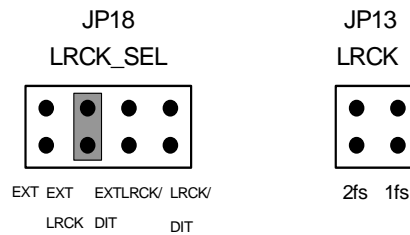

(4) Evaluation of EXT, Slave

***Connect PORT4 (DSP2) with DSP.**

Figure below shows PORT4 pin assign

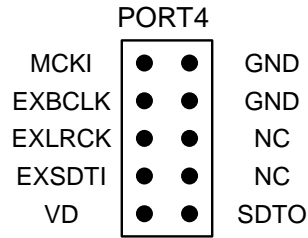

a) Set up jumper pins of MCKI clock

PORT4 (DSP2) is used. JP19 (MCKI_SEL) should be open.

b) Set up jumper pins of BCLK clock

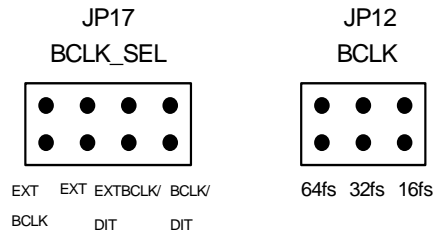

c) Set up jumper pins of LRCK clock

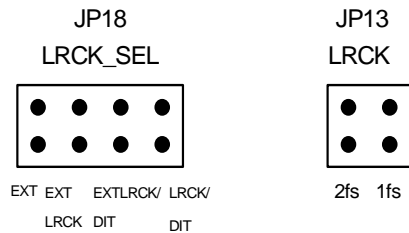

d) Set up jumper pins of DATA

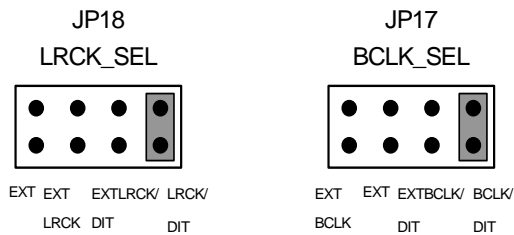

(5) Slave & Bypass Mode

***Connect PORT4 (DSP2) and PORT2 (DSP1) with DSP.**

Figure below shows PORT4 and PORT2 pin assign.



a) Set up jumper pins of MCKI clock

PORT4 (DSP2) is used. JP19 (MCKI_SEL) should be open.

b) Set up jumper pins of BCLK clock

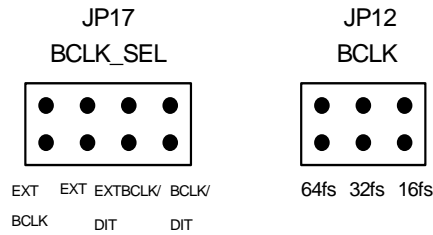

c) Set up jumper pins of LRCK clock

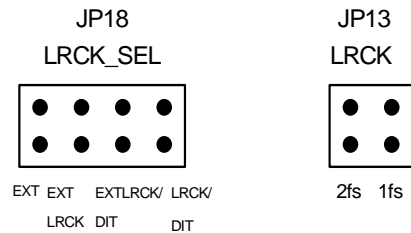

d) Set up jumper pins of DATA

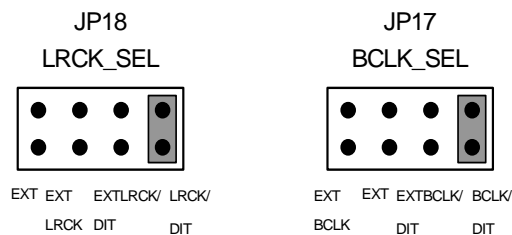

(6) Bypass Mode

***Connect PORT4 (DSP2) and PORT2 (DSP1) with DSP.**

Figure below shows PORT4 and PORT2 pin assign.

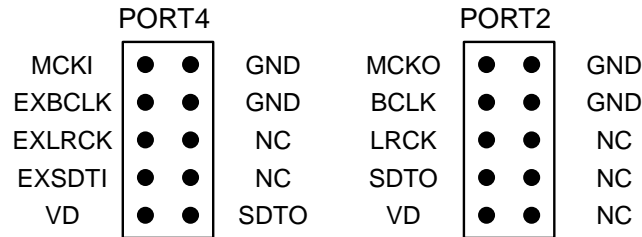

a) Set up jumper pins of MCKI clock

PORT4 (DSP2) is used. JP19 (MCKI_SEL) should be open.

b) Set up jumper pins of BCLK clock

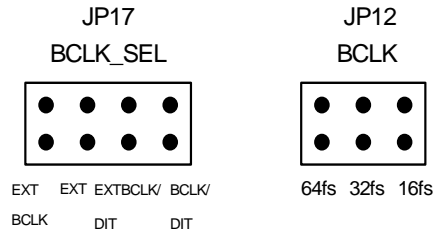

c) Set up jumper pins of LRCK clock

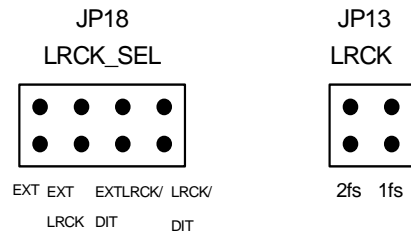

d) Set up jumper pins of DATA

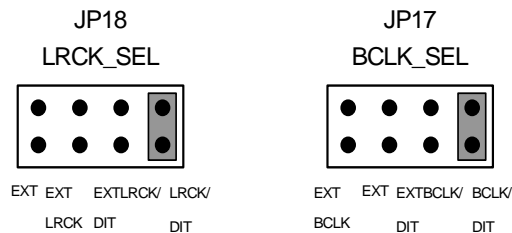

■ DIP Switch set up

[SW2] (MODE): Mode Setting of AK4114
ON is “H”, OFF is “L”.

No.	Name	ON (“H”)	OFF (“L”)
1	DIF0	AK4114 Audio Format Setting See Table 2	
2	DIF1		
3	OCKS0	Master Clock Frequency Select See Table 3	
4	OCKS1		

Table 1. Mode Setting

Resistor for AK5700			Set up for AK4114 SW3			
M/S	DIF1	DIF0	DIF1	DIF0	DAUX	
0	1	0	0	0	24bit, Left justified	Master
0	1	1	0	1	24bit, I ² S	Master
1	1	0	1	0	24bit, Left justified	Slave
1	1	1	1	1	24bit, I ² S	Slave

Default

Table 2. Setting for AK5700 and AK4114 Audio Interface Format

No.	OCKS1	OCKS0	MCKO1	X'tal
0	0	0	256fs	256fs
2	1	0	512fs	512fs

Default

Table 3. Master Clock Frequency Select for AK4114 (Stereo mode)

■ Other jumper pins set up

1. JP1 (GND) : Analog ground and Digital ground
 OPEN : Separated.
 SHORT : Common. (The connector "DGND" should be open.) <Default>
2. JP2 (AVDD_SEL) : AVDD of the AK5700
 OPEN : AVDD is supplied from the regulator ("AVDD" jack should be open). < Default >
 SHORT : AVDD is supplied from "AVDD" jack.
3. JP3 (DVDD_SEL) : DVDD of the AK5700
 AVDD : DVDD is supplied from "AVDD". < Default >
 DVDD : DVDD is supplied from "DVDD" jack.
4. JP4 (CSP) : CSP signal Select (Hi or Low)
 H : CSP= "Hi"
 L : CSP= "Low"< Default >
5. JP5, JP6 (MPWR) : Connect to MPWR
 OPEN : No connect< Default >
 SHORT : Connect
6. JP7 (LVC_SEL) : Supply line selection of Logic block of LVC.
 DVDD : Logic block of LVC is supplied from "DVDD". < Default >
 VD : Logic block of LVC is supplied from "VD" jack.
7. JP20 (SDTO) : Select #4 pin of the PORT4 (DSP)
 OPEN : Input data for EXSDTI<Default>
 SHORT : Output data for SDTO of the PORT4
8. JP8 (CCLK) : CCLK select
 OPEN : No connect
 SHORT : CCLK connect <Default>

■ **The function of the toggle SW**

[SW1] (DIT): Power control of AK4114. Keep “H” during normal operation.
 Keep “L” when AK4114 is not used.

[SW3] (PDN): Power control of AK5700. Keep “H” during normal operation.

■ **Indication for LED**

[LED1] (ERF): Monitor INT0 pin of the AK4114. LED turns on when some error has occurred to AK4114.

■ **Serial Control**

The AK5700 can be controlled via the printer port (parallel port) of IBM-AT compatible PC. Connect PORT3 (CTRL) with PC by 10-wire flat cable packed with the AKD5700-A

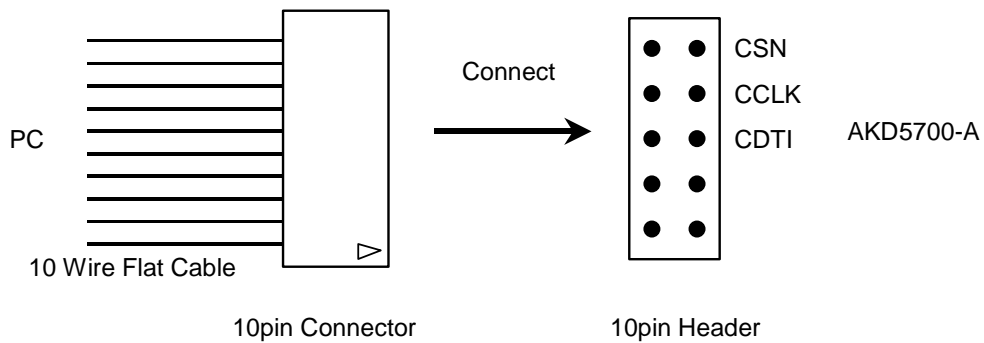

Figure 2. Connect of 10 wire flat cable

■ Analog Input / Output Circuits

(1) Input Circuits

a) AIN1, AIN- MIC Input Circuit

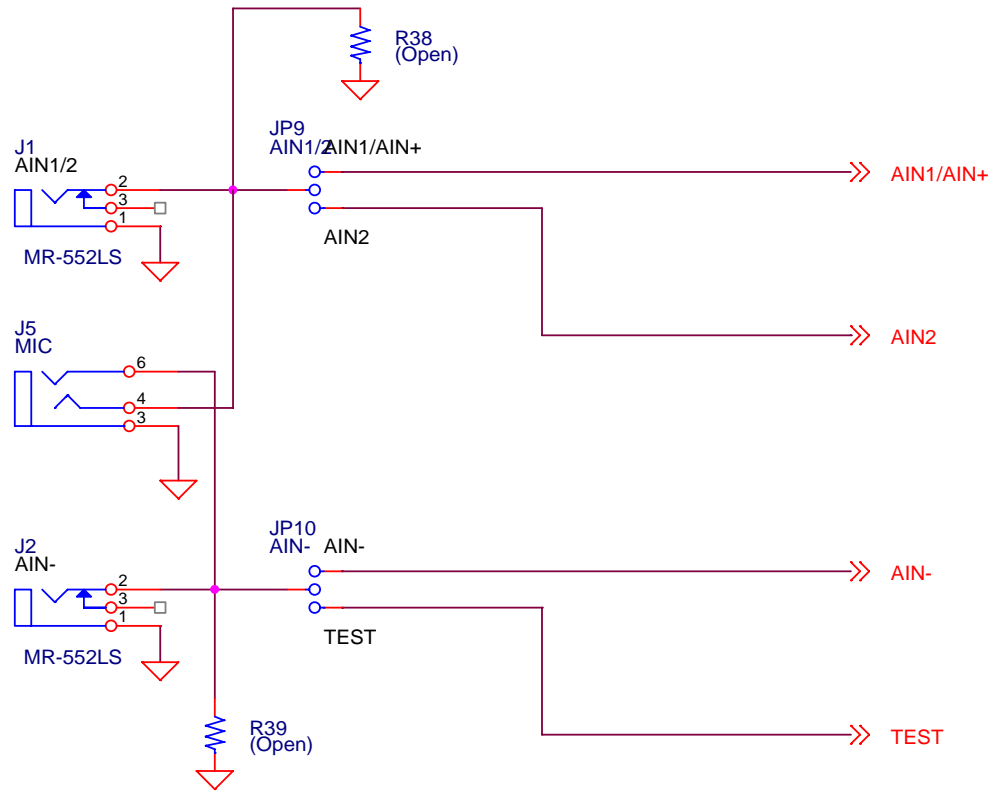
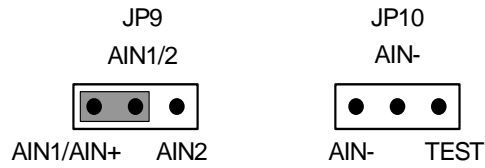
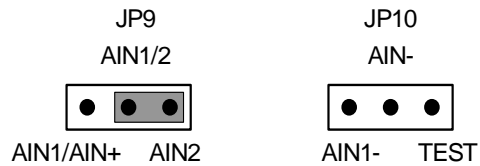

Figure 3. AIN1, AIN2, MIC Input Circuit

(a-1) AIN1 input



(a-2) AIN2 input



* AKM assumes no responsibility for the trouble when using the above circuit examples.

2. Control Software Manual

■ Set-up of evaluation board and control software

1. Set up the AKD5700-A according to previous term.
2. Connect IBM-AT compatible PC with AKD5700-A by 10-line type flat cable (packed with AKD5700-A). Take care of the direction of 10pin header. (Please install the driver in the CD-ROM when this control software is used on Windows 2000/XP. Please refer “Installation Manual of Control Software Driver by AKM device control software”. In case of Windows95/98/ME, this installation is not needed. This control software does not operate on Windows NT.)
3. Insert the CD-ROM labeled “AK5700 Evaluation Kit” into the CD-ROM drive.
4. Access the CD-ROM drive and double-click the icon of “akd5700-a.exe” to set up the control program.
5. Then please evaluate according to the follows.

■ Operation flow

Keep the following flow.

1. Set up the control program according to explanation above.
2. Click “Port Reset” button.
3. Click “Write default” button

■ Explanation of each buttons

1. [Port Reset] : Set up the USB interface board (AKDUSBIF-A) when using the board.
2. [Write default] : Initialize the register of AK5700-A.
3. [All Write] : Write all registers that is currently displayed.
4. [Function1] : Dialog to write data by keyboard operation.
5. [Function2] : Dialog to write data by keyboard operation.
6. [Function3] : The sequence of register setting can be set and executed.
7. [Function4] : The sequence that is created on [Function3] can be assigned to buttons and executed.
8. [Function5] : The register setting that is created by [SAVE] function on main window can be assigned to buttons and executed.
9. [SAVE] : Save the current register setting.
10. [OPEN] : Write the saved values to all register.
11. [Write] : Dialog to write data by mouse operation.

■ Indication of data

Input data is indicated on the register map. Red letter indicates “H” or “1” and blue one indicates “L” or “0”. Blank is the part that is not defined in the datasheet.

■ Explanation of each dialog

1. [Write Dialog]: Dialog to write data by mouse operation

There are dialogs corresponding to each register.

Click the [Write] button corresponding to each register to set up the dialog. If you check the check box, data becomes "H" or "I". If not, "L" or "O".

If you want to write the input data to AK5700, click [OK] button. If not, click [Cancel] button.

2. [Function1 Dialog] : Dialog to write data by keyboard operation

Address Box: Input registers address in 2 figures of hexadecimal.

Data Box: Input registers data in 2 figures of hexadecimal.

If you want to write the input data to AK5700, click [OK] button. If not, click [Cancel] button.

3. [Function2 Dialog] : Dialog to evaluate IVOL

There are dialogs corresponding to register of 18h and 19h.

Address Box: Input registers address in 2 figures of hexadecimal.

Start Data Box: Input starts data in 2 figures of hexadecimal.

End Data Box: Input end data in 2 figures of hexadecimal.

Interval Box: Data is written to AK5700 by this interval.

Step Box: Data changes by this step.

Mode Select Box:

If you check this check box, data reaches end data, and returns to start data.

[Example] Start Data = 00, End Data = 09

Data flow: 00 01 02 03 04 05 06 07 08 09 09 08 07 06 05 04 03 02 01 00

If you do not check this check box, data reaches end data, but does not return to start data.

[Example] Start Data = 00, End Data = 09

Data flow: 00 01 02 03 04 05 06 07 08 09

If you want to write the input data to AK5700, click [OK] button. If not, click [Cancel] button.

4. [SAVE] and [OPEN]

4-1. [SAVE]

All of current register setting values displayed on the main window are saved to the file. The extension of file name is “akr”.

<Operation flow>

- (1) Click [SAVE] Button.
- (2) Set the file name and click [SAVE] Button. The extension of file name is “akr”.

4-2. [OPEN]

The register setting values saved by [SAVE] are written to the AK5700. The file type is the same as [SAVE].

<Operation flow>

- (1) Click [OPEN] Button.
- (2) Select the file (*.akr) and Click [OPEN] Button.

5. [Function3 Dialog]

The sequence of register setting can be set and executed.

(1) Click [F3] Button. The following is displayed.

(2) Set the control sequence.

Set the address, Data and Interval time. Set “-1” to the address of the step where the sequence should be paused.

(3) Click [START] button. Then this sequence is executed.

The sequence is paused at the step of Interval="-1". Click [START] button, the sequence restarts from the paused step.

This sequence can be saved and opened by [SAVE] and [OPEN] button on the Function3 window. The extension of file name is “aks”.

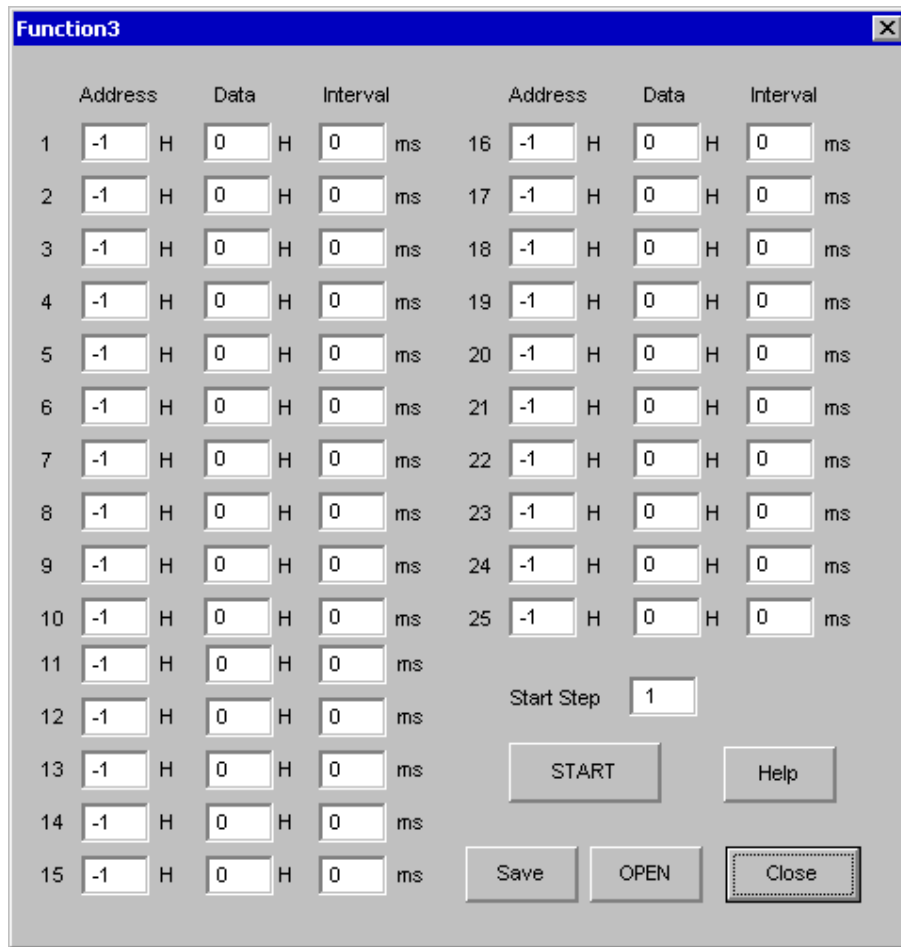

Figure 1. Window of [F3]

6. [Function4 Dialog]

The sequence file (*.aks) saved by [Function3] can be listed up to 10 files, assigned to buttons and then executed. When [F4] button is clicked, the window as shown in Figure 2 opens.

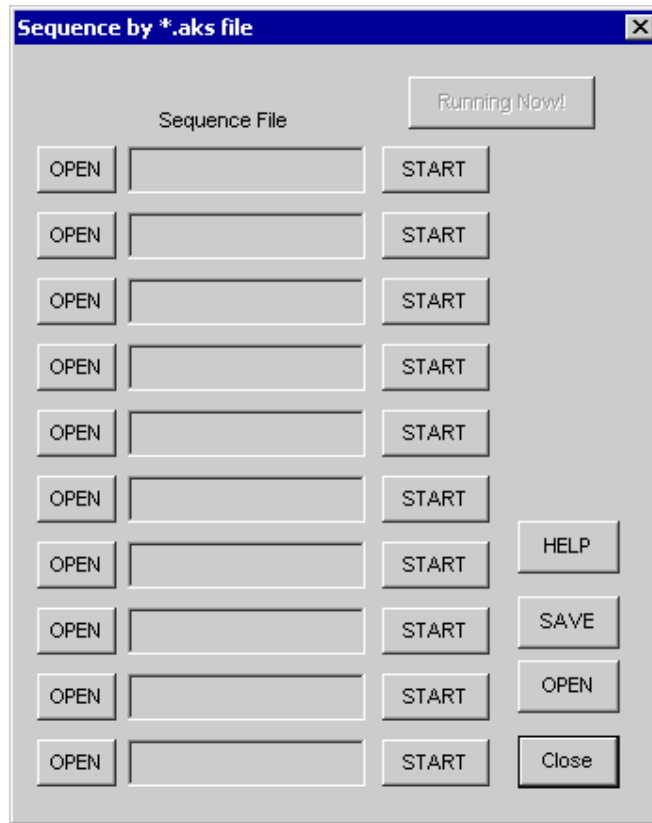

Figure 2. [F4] window

6-1. [OPEN] buttons on left side and [START] buttons

(1) Click [OPEN] button and select the sequence file (*.aks) saved by [Function3].

The sequence file name is displayed as shown in Figure 3. (In case that the selected sequence file name is "DAC_Stereo_ON.aks")

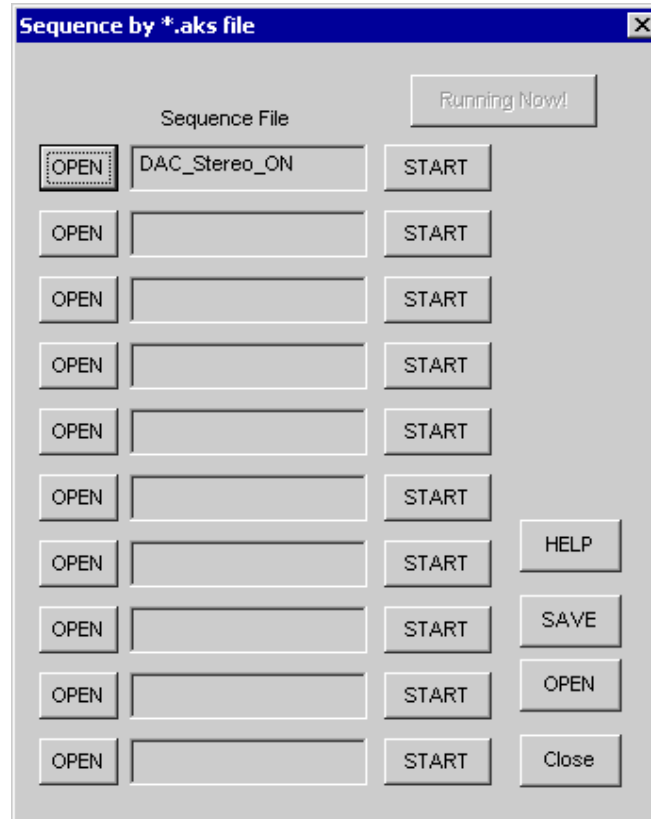

Figure 3. [F4] window(2)

(2) Click [START] button, then the sequence is executed.

6-2. [SAVE] and [OPEN] buttons on right side

[SAVE] : The name assign of sequence file displayed on [Function4] window can be saved to the file. The file name is "*.ak4".

[OPEN] : The name assign of sequence file (*.ak4) saved by [SAVE] is loaded.

6-3. Note

- (1) This function doesn't support the pause function of sequence function.
- (2) All files used by [SAVE] and [OPEN] function on right side need to be in the same folder.
- (3) When the sequence is changed in [Function3], the sequence file (*.aks) should be loaded again in order to reflect the change.

7. [Function5 Dialog]

The register setting file(*.akr) saved by [SAVE] function on main window can be listed up to 10 files, assigned to buttons and then executed. When [F5] button is clicked, the window as shown in Figure 4 opens.

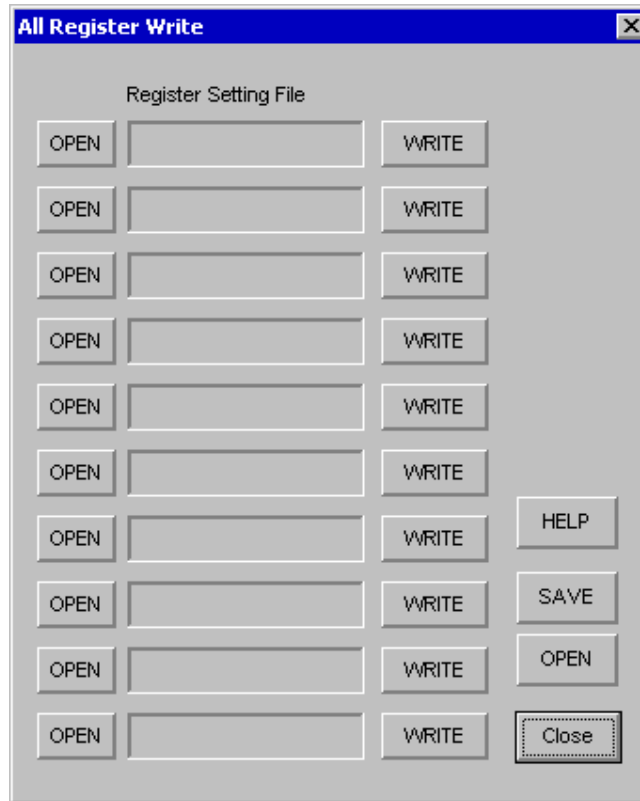

Figure 4. [F5] window

7-1. [OPEN] buttons on left side and [WRITE] button

- (1) Click [OPEN] button and select the register setting file (*.akr).

The register setting file name is displayed as shown in Figure 5. (In case that the selected file name is "DAC_Output.akr")

- (2) Click [WRITE] button, then the register setting is executed.

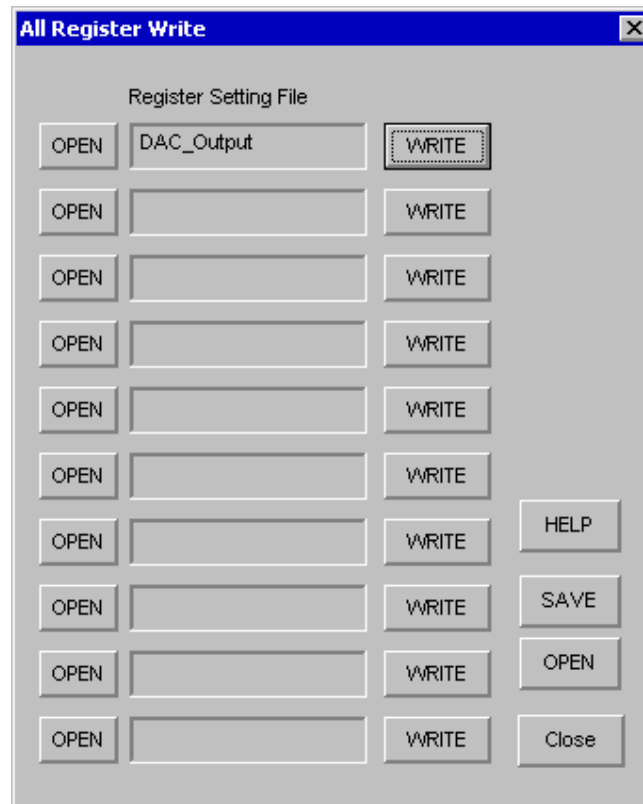

Figure 5. [F5] windows(2)

7-2. [SAVE] and [OPEN] buttons on right side

[SAVE] : The name assign of register setting file displayed on [Function5] window can be saved to the file. The file name is "*.ak5".

[OPEN] : The name assign of register setting file(*.ak5) saved by [SAVE] is loaded.

7-3. Note

- (1) All files used by [SAVE] and [OPEN] function on right side need to be in the same folder.
- (2) When the register setting is changed by [SAVE] Button on the main window, the register setting file (*.akr) should be loaded again in order to reflect the change.

MEASUREMENT RESULTS

1.AK5700 Mode: EXT mode (Slave)

[Measurement condition]

- Measurement unit: AP2 (Audio Precision, System two, Cascade)
- MCKI: 256fs
- BCLK: 64fs
- Bit: 16bit
- Sampling Frequency: 44.1kHz
- Measurement Frequency: 20 ~ 20kHz
- Power Supply: AVDD=DVDD=VD=3.0V
- Temperature: Room
- Input Frequency: 1kHz

[Measurement Results]

1.ADC characteristics (MIC Gain = 0dB, IVOL=0dB, ALC = OFF, AIN1 → ADC)

	Result	
	MGAIN=0dB	MGAIN=+15dB
	AIN1	AIN1
S/(N+D) (-0.5dBFS)	79.0dB	78.3dB
D-Range (-60dBFS)	89.8dB	87.7dB
S/N	89.9dB	87.7dB

2.AK5700 Mode: PLL MASTER mode

[Measurement condition]

- Measurement unit: AP2 (Audio Precision, System two, Cascade)
- MCKI: 12MHz
- BCLK: 64fs
- Bit: 16bit
- Sampling Frequency: 44.0995kHz
- Measurement Frequency: 20 ~ 20kHz
- Power Supply: AVDD=DVDD=VD=3.0V
- Temperature: Room
- Input Frequency: 1kHz

[Measurement Results]

ADC characteristics

	Result	
	MGAIN=0dB	MGAIN=+15dB
	AIN1	AIN1
S/(N+D) (-0.5dBFS)	78.7dB	77.9dB
D-Range (-60dBFS)	89.3dB	87.4dB
S/N	89.3dB	87.4dB

3. Plot data

[Gain = 0dB]
AKM

AK5700 THD+N vs Input Level (fin=1kHz, GAIN=0dB)

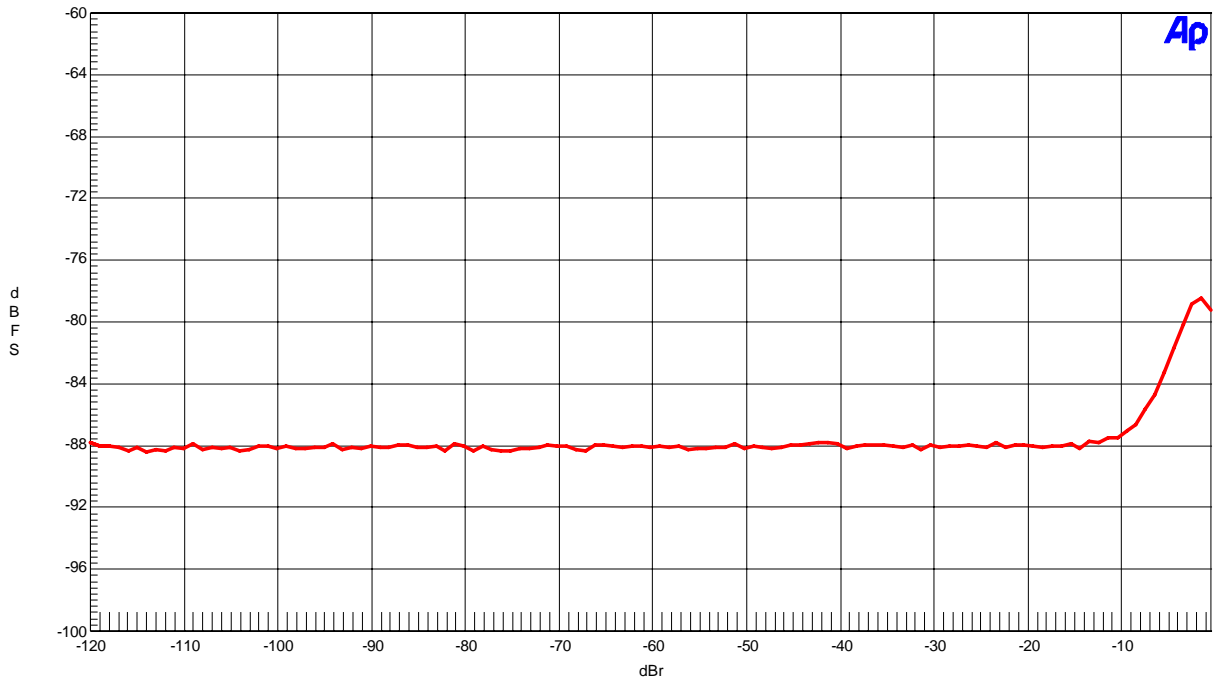

Figure 1. THD+N vs. Input Level

AKM

AK5700 THD+N vs Frequency (fin=1kHz, GAIN=0dB)

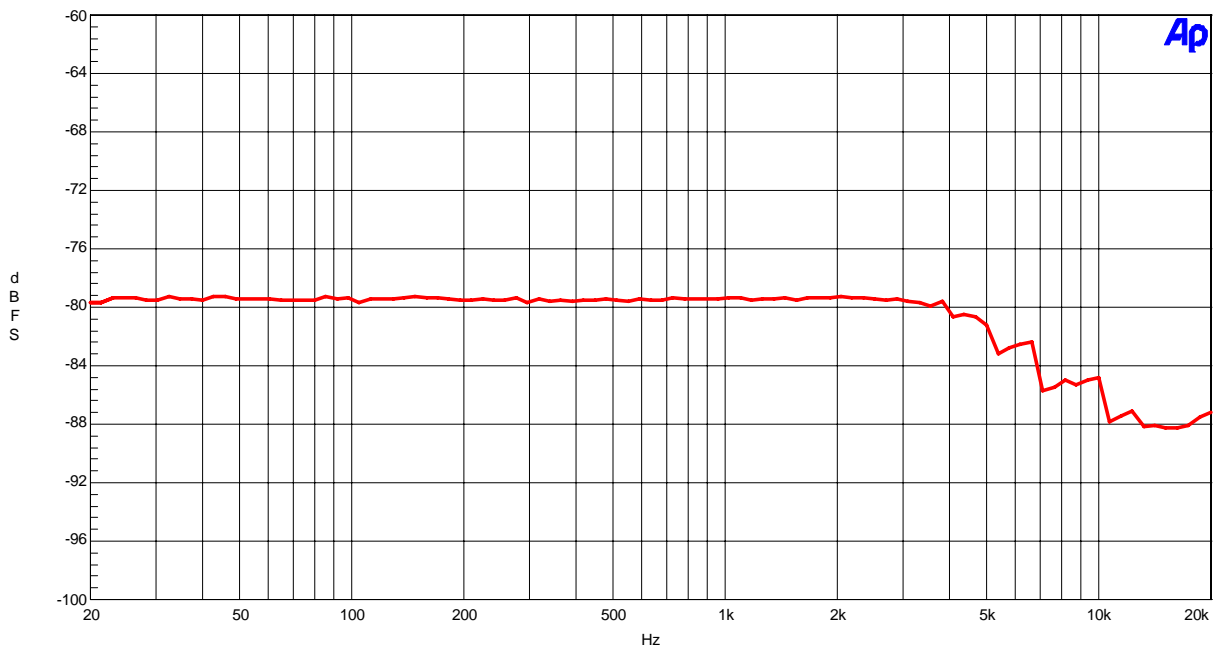

Figure 2. THD+N vs. Input Frequency

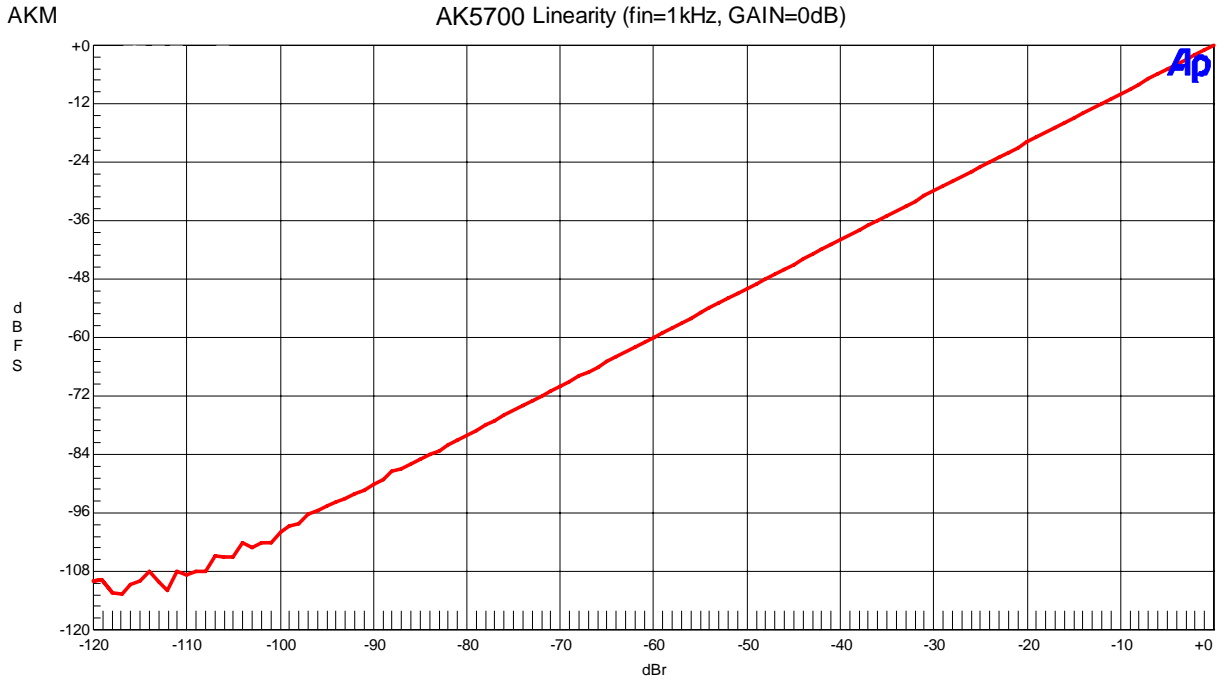

Figure 3. Linearity

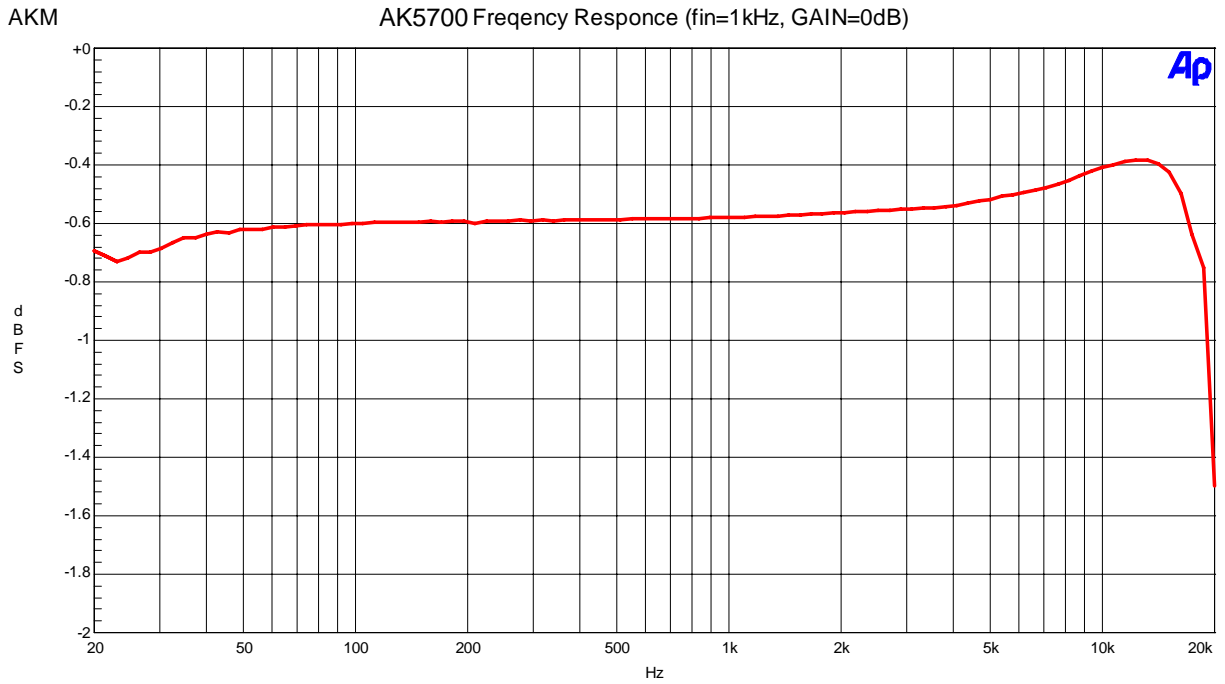

Figure 4. Frequency Response

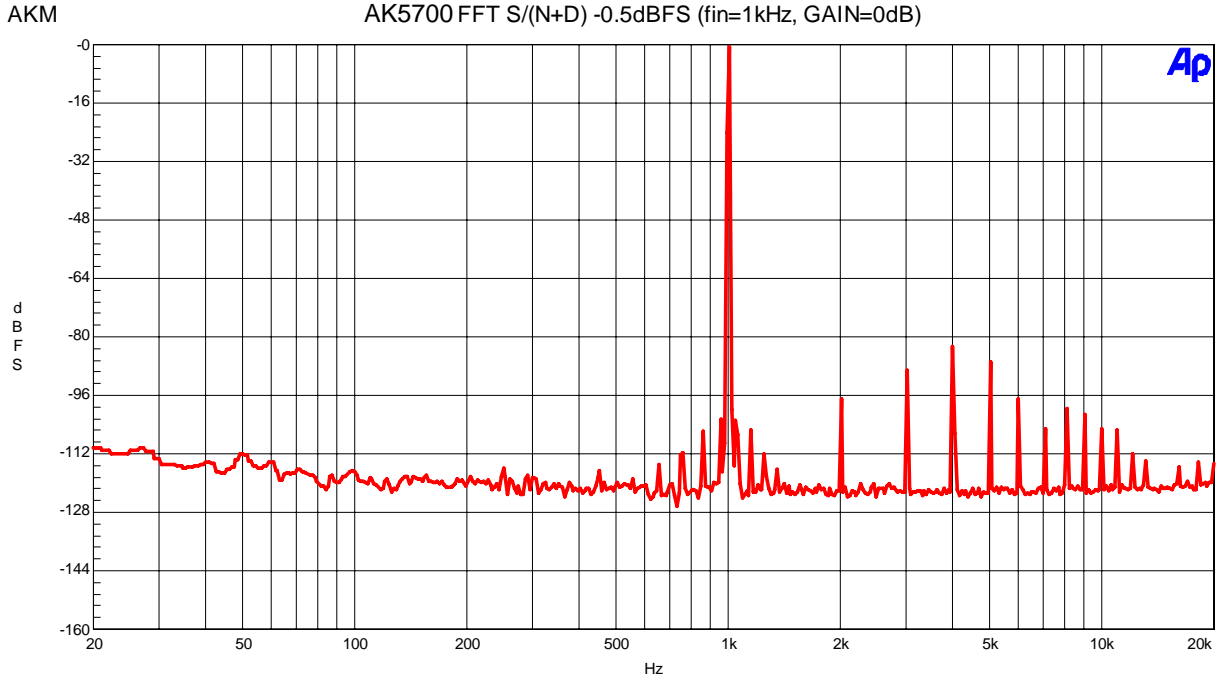

Figure 5. FFT Plot

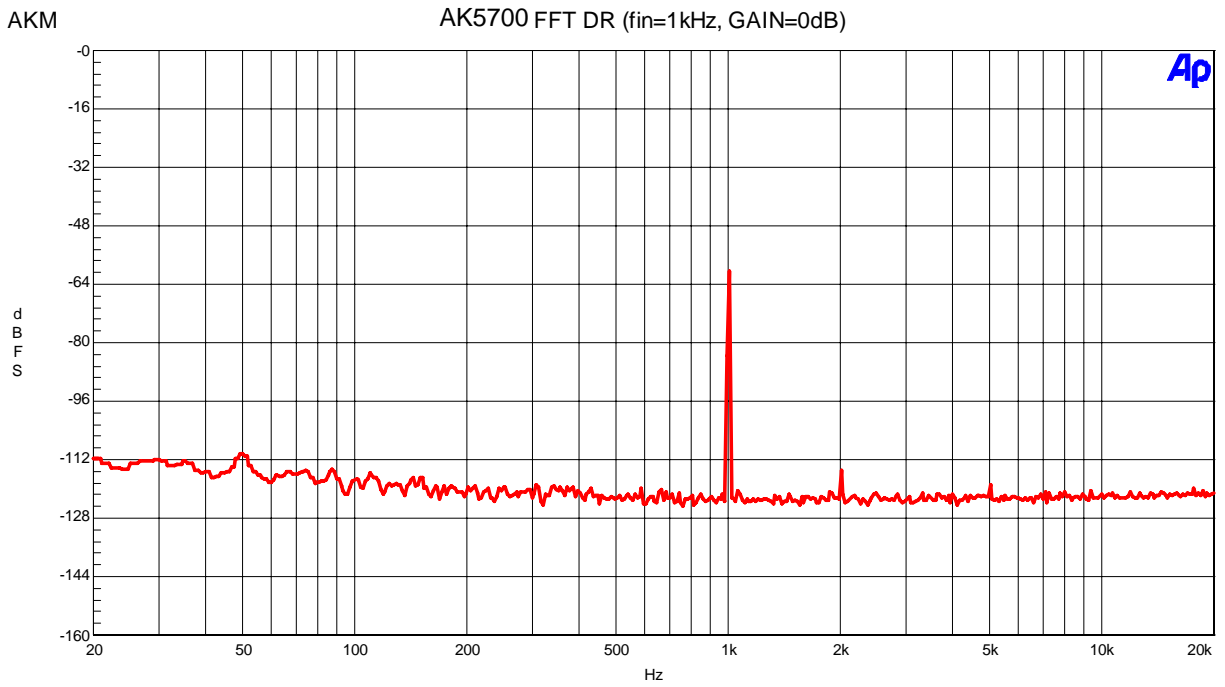

Figure 6. FFT Plot

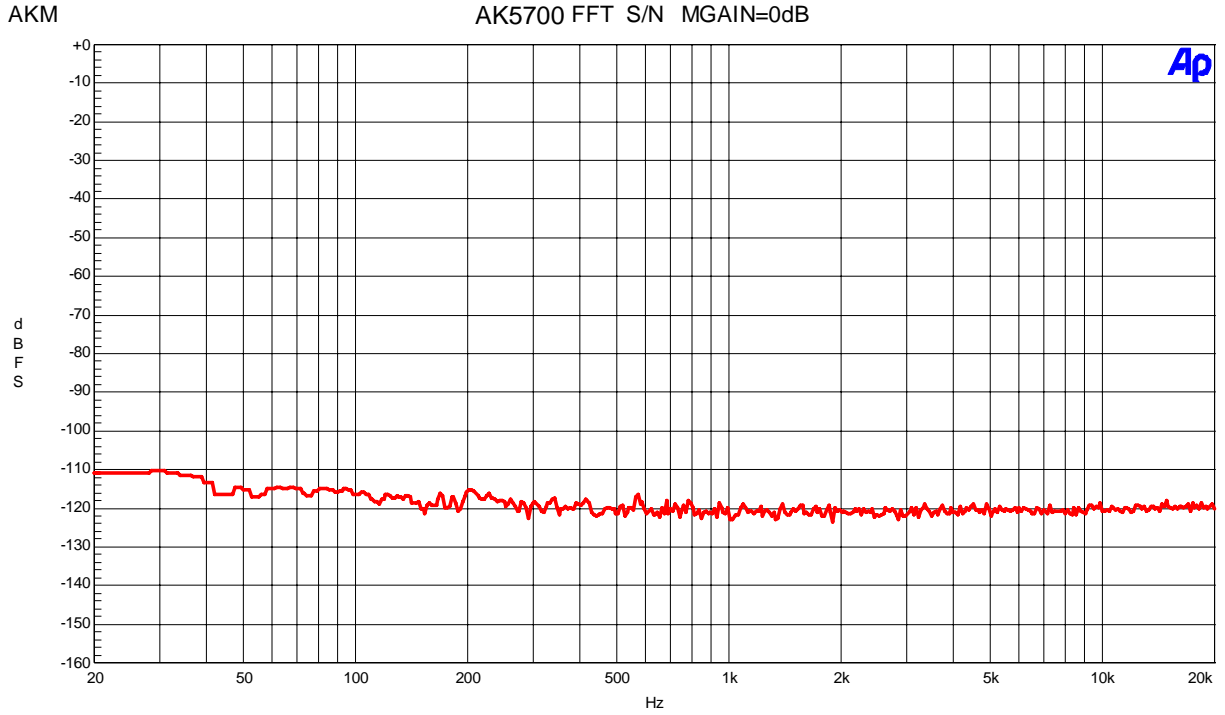

Figure 7. FFT Plot

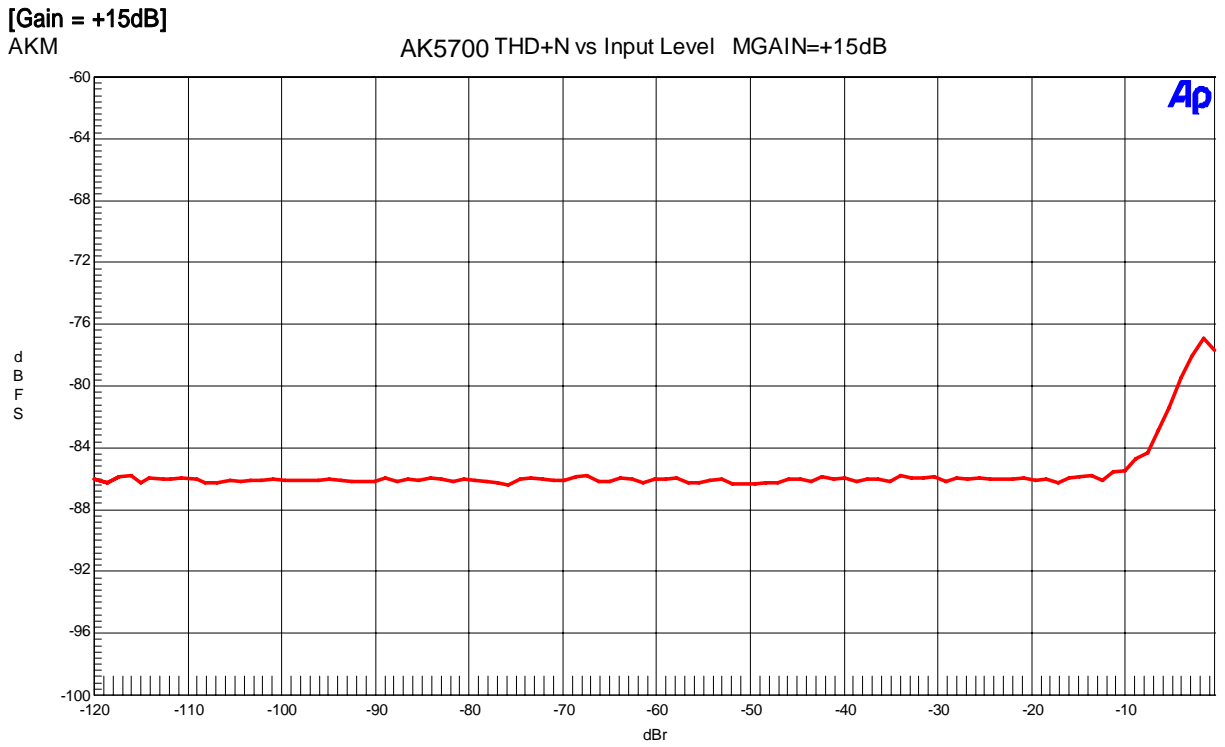

Figure 8. THD+N vs. Input Level

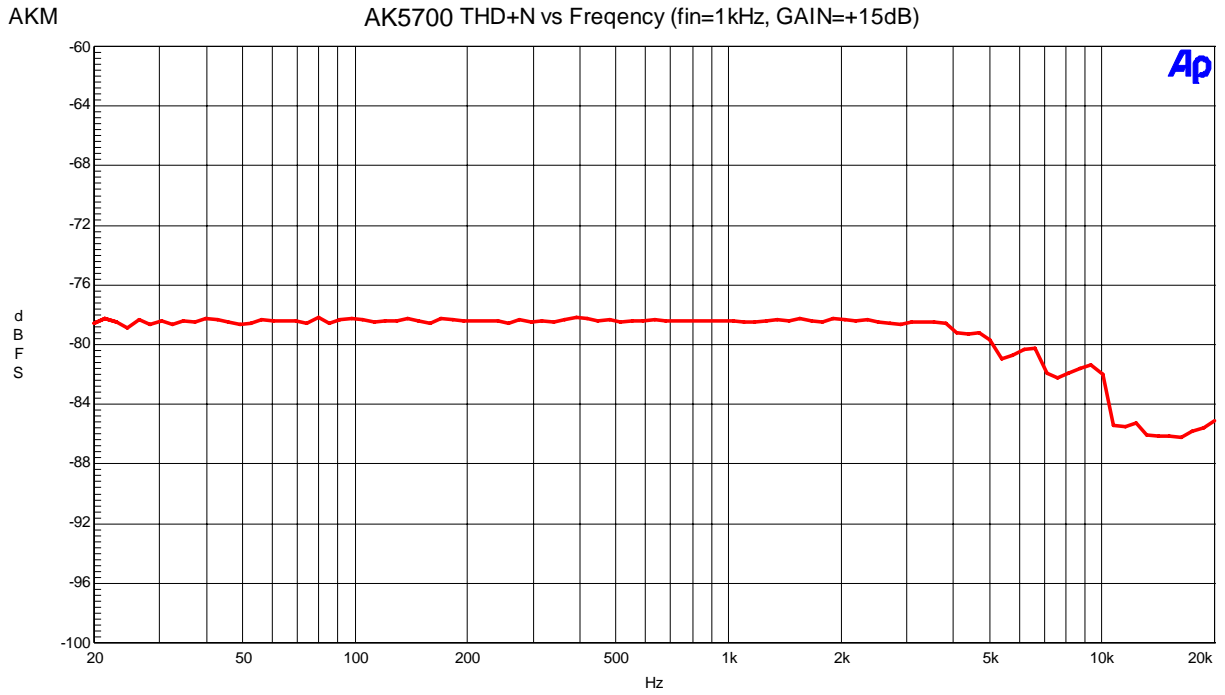

Figure 9. THD+N vs. Input Frequency

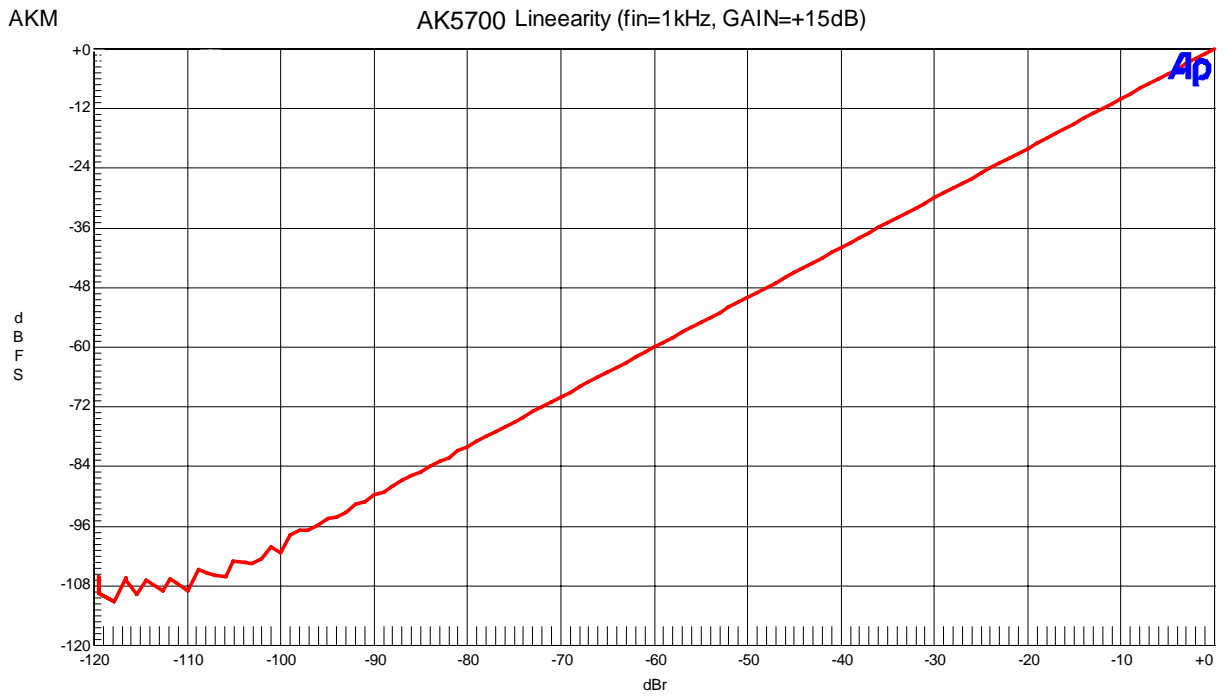

Figure 10. Linearity

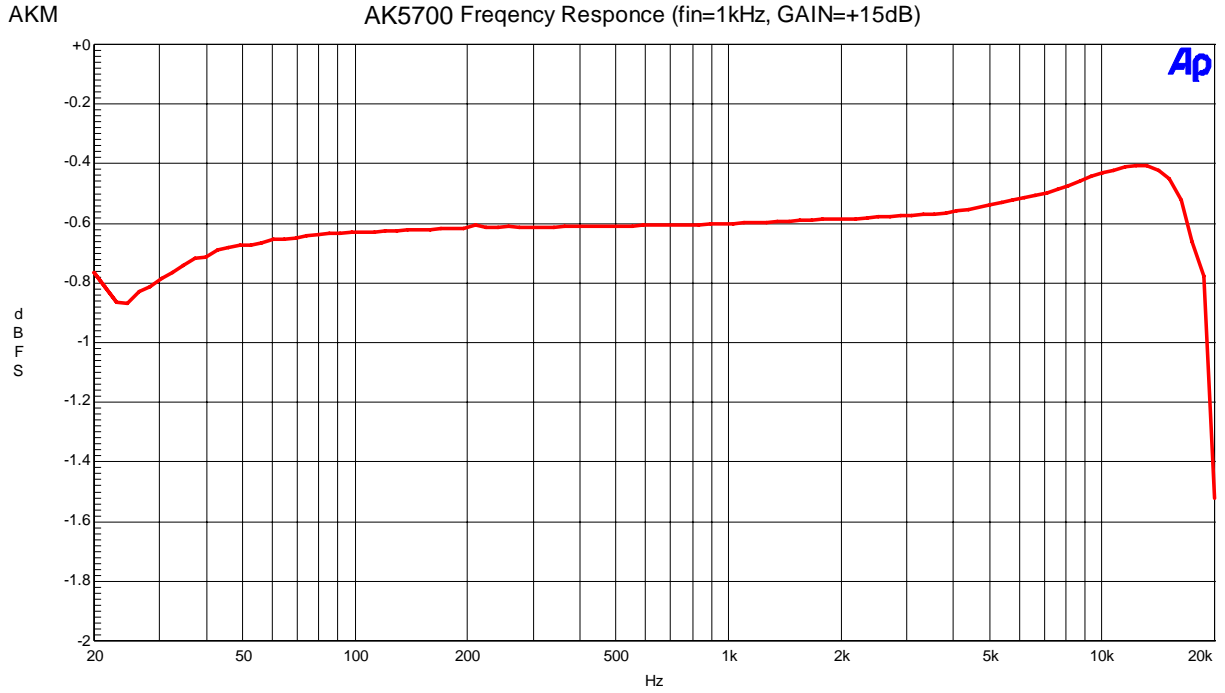

Figure 11.Frequency Response

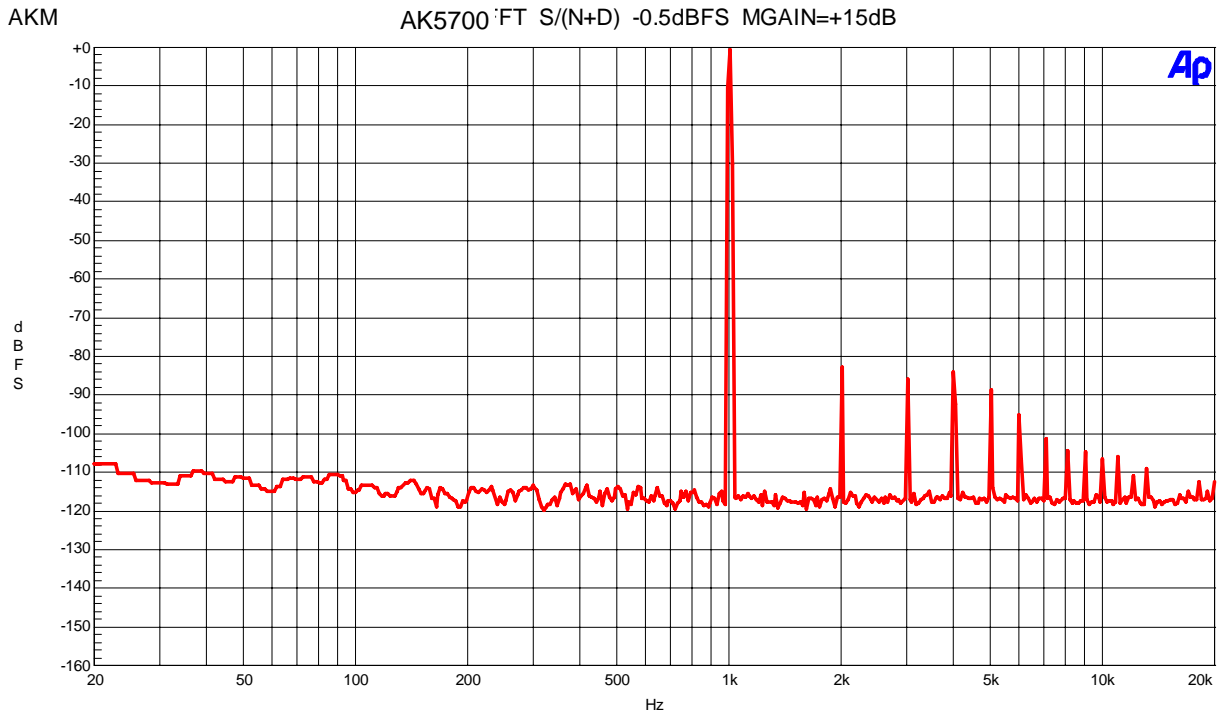

Figure 12. FFT Plot

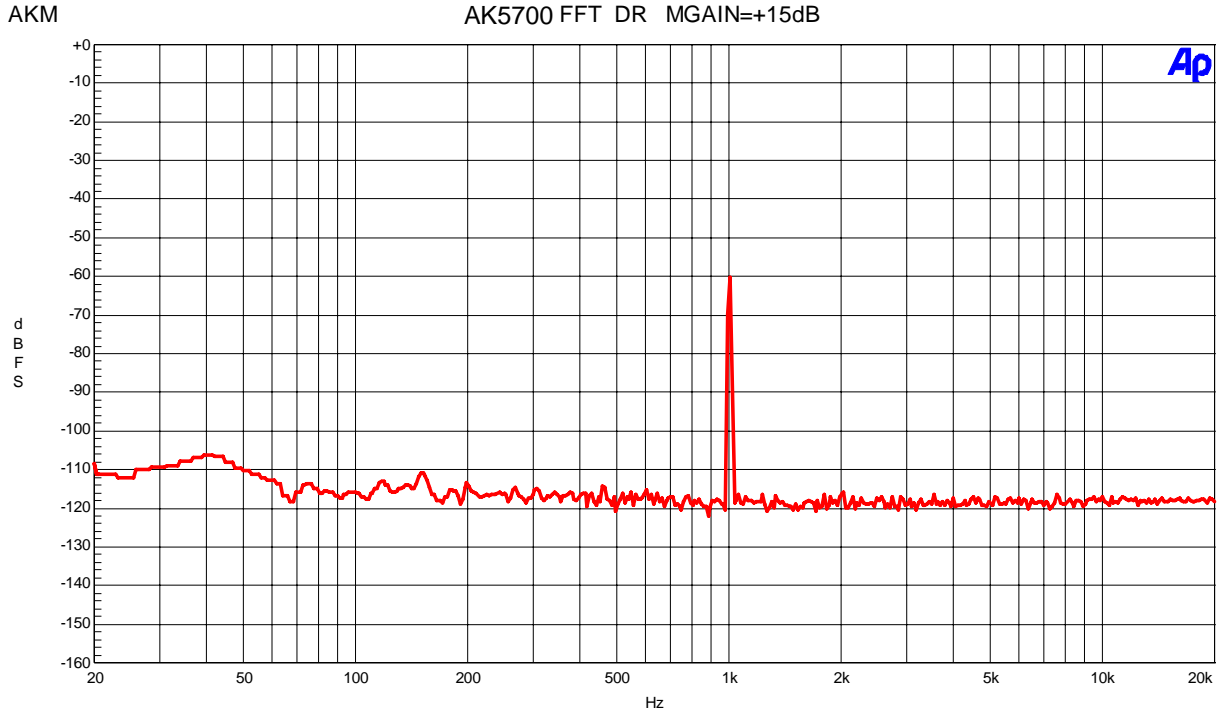

Figure 13. FFT Plot

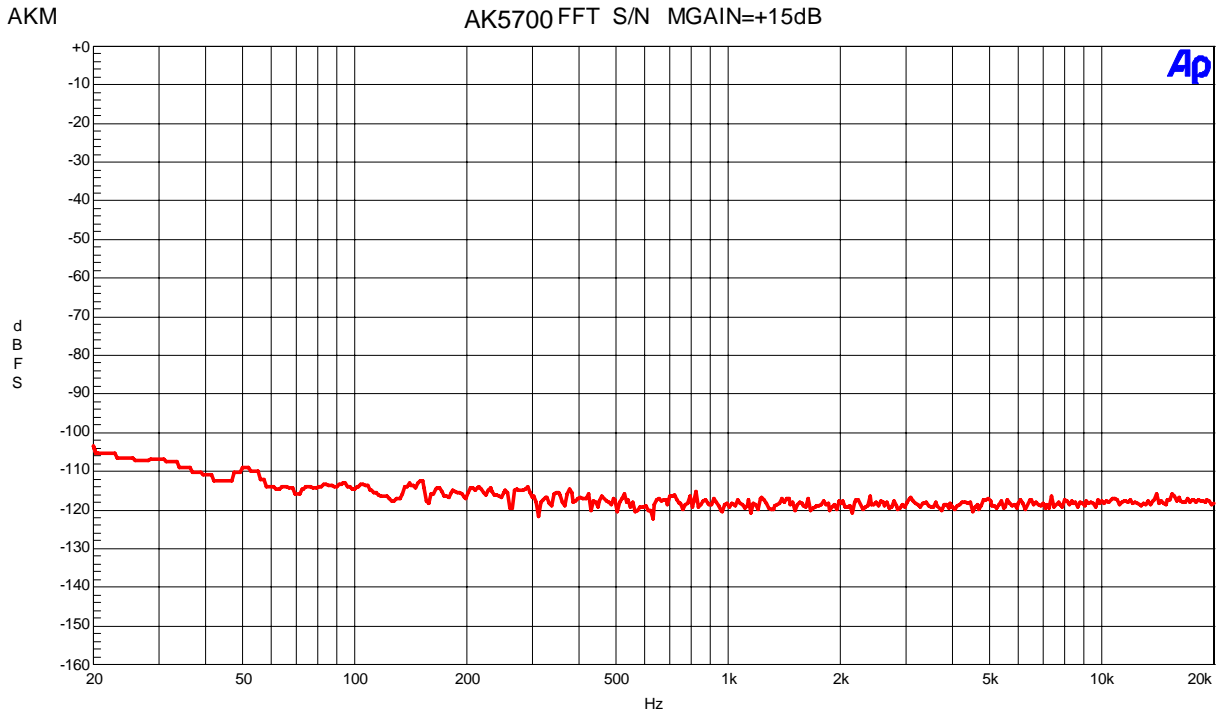
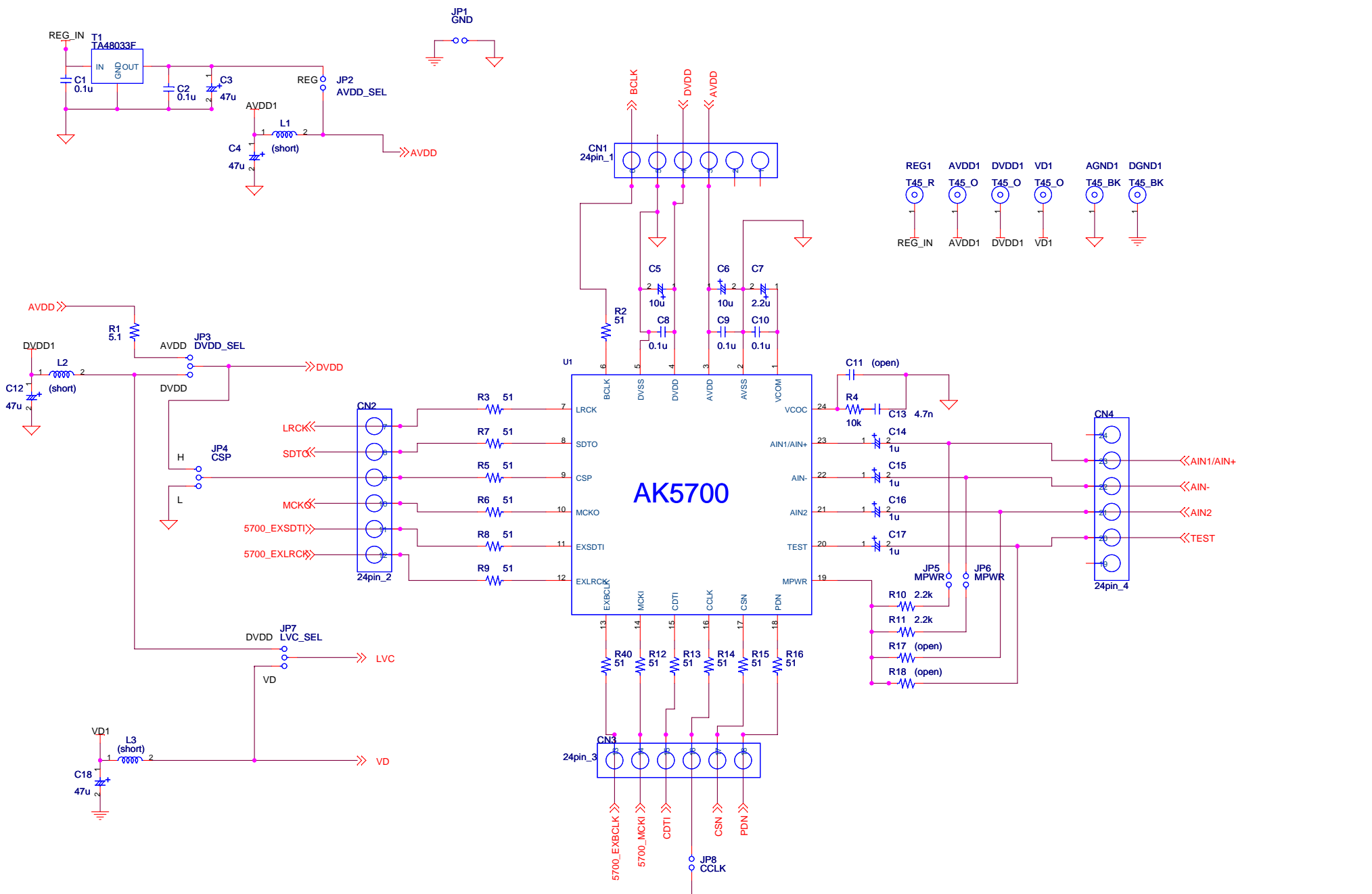

Figure 14. FFT Plot

Revision History				
Date	Manual Revision	Board Revision	Reason	Contents
06/12/27	KM087000	0	First Edition	

IMPORTANT NOTICE

- These products and their specifications are subject to change without notice. Before considering any use or application, consult the Asahi Kasei Microsystems Co., Ltd. (AKM) sales office or authorized distributor concerning their current status.
- AKM assumes no liability for infringement of any patent, intellectual property, or other right in the application or use of any information contained herein.
- Any export of these products, or devices or systems containing them, may require an export license or other official approval under the law and regulations of the country of export pertaining to customs and tariffs, currency exchange, or strategic materials.
- AKM products are neither intended nor authorized for use as critical components in any safety, life support, or other hazard related device or system, and AKM assumes no responsibility relating to any such use, except with the express written consent of the Representative Director of AKM. As used here:
 - (a) A hazard related device or system is one designed or intended for life support or maintenance of safety or for applications in medicine, aerospace, nuclear energy, or other fields, in which its failure to function or perform may reasonably be expected to result in loss of life or in significant injury or damage to person or property.
 - (b) A critical component is one whose failure to function or perform may reasonably be expected to result, whether directly or indirectly, in the loss of the safety or effectiveness of the device or system containing it, and which must therefore meet very high standards of performance and reliability.
- It is the responsibility of the buyer or distributor of an AKM product who distributes, disposes of, or otherwise places the product with a third party to notify that party in advance of the above content and conditions, and the buyer or distributor agrees to assume any and all responsibility and liability for and hold AKM harmless from any and all claims arising from the use of said product in the absence of such notification.



Title			AKD5700-A		
Size	Document Number	Rev			
A3	AK5700	1			
Date:	Wednesday, December 27, 2006	Sheet	1	of	5

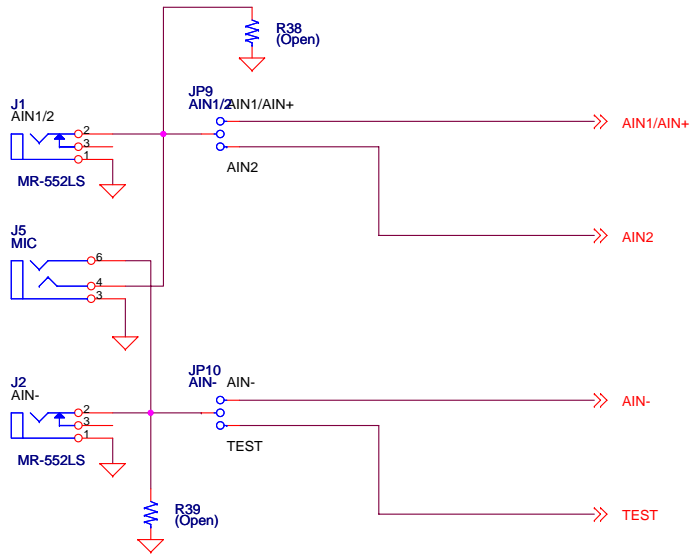

Title			AKD5700-A		
Size	Document Number	Input		Rev	1
Date: Wednesday, December 27, 2006			Sheet	2	of 5

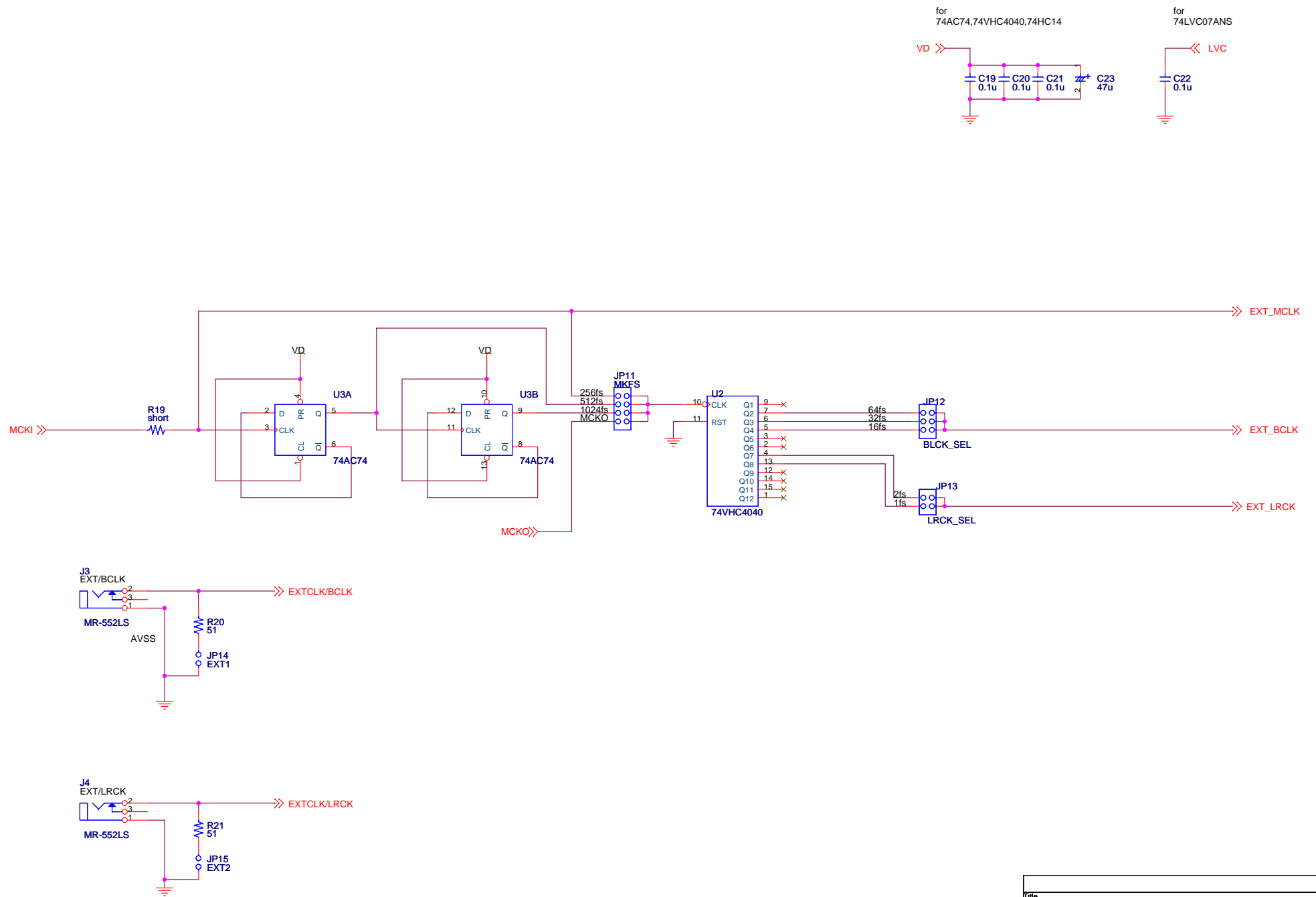

Title			AKD5700-A		
Size	Document Number	CLOCK			Rev
A3					1
Date:	Wednesday, December 27, 2006	Sheet	3	of	5

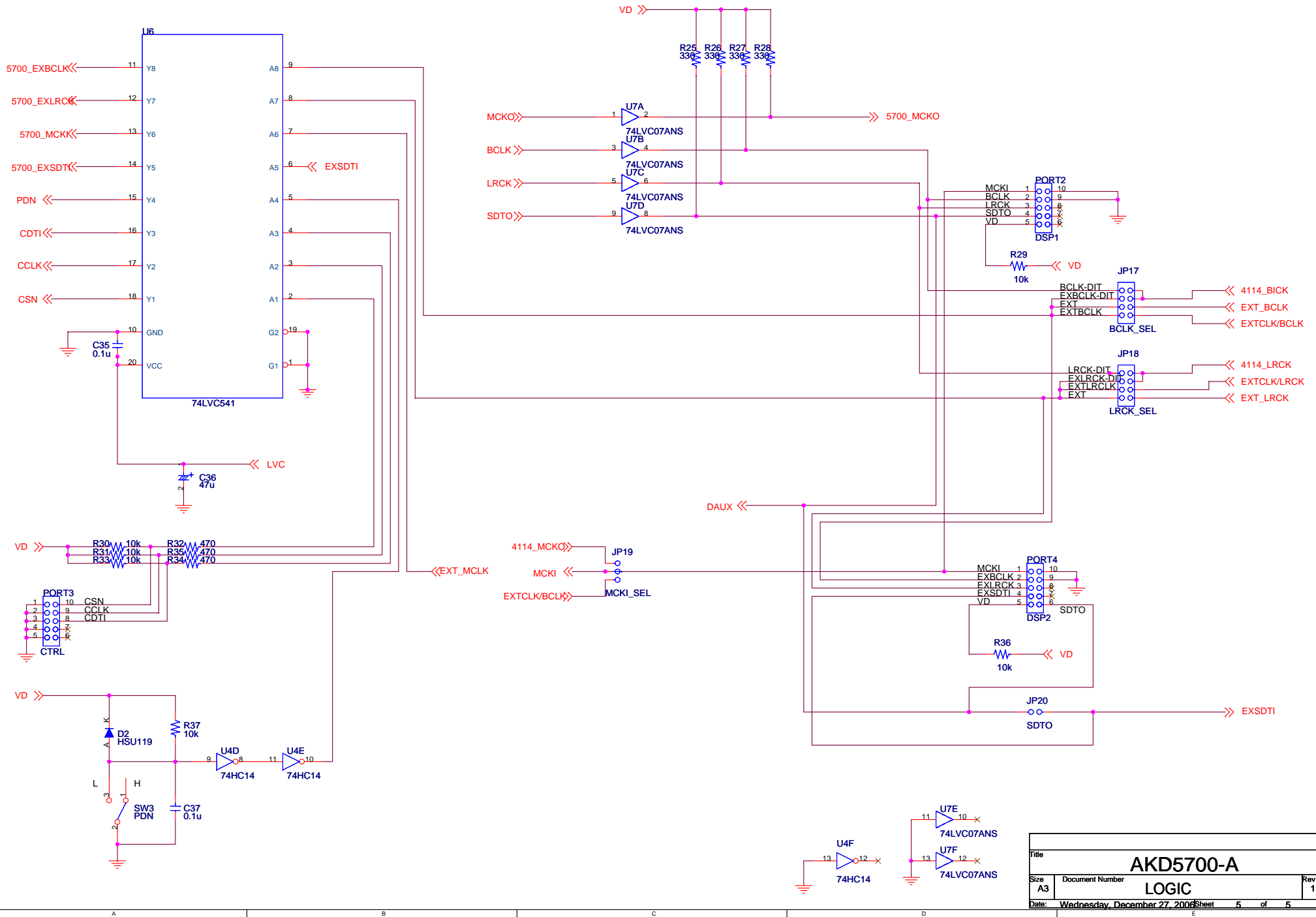

Title			AKD5700-A		
Size	Document Number	LOGIC			Rev
A3					1
Date:	Wednesday, December 27, 2006				Sheet 5 of 5

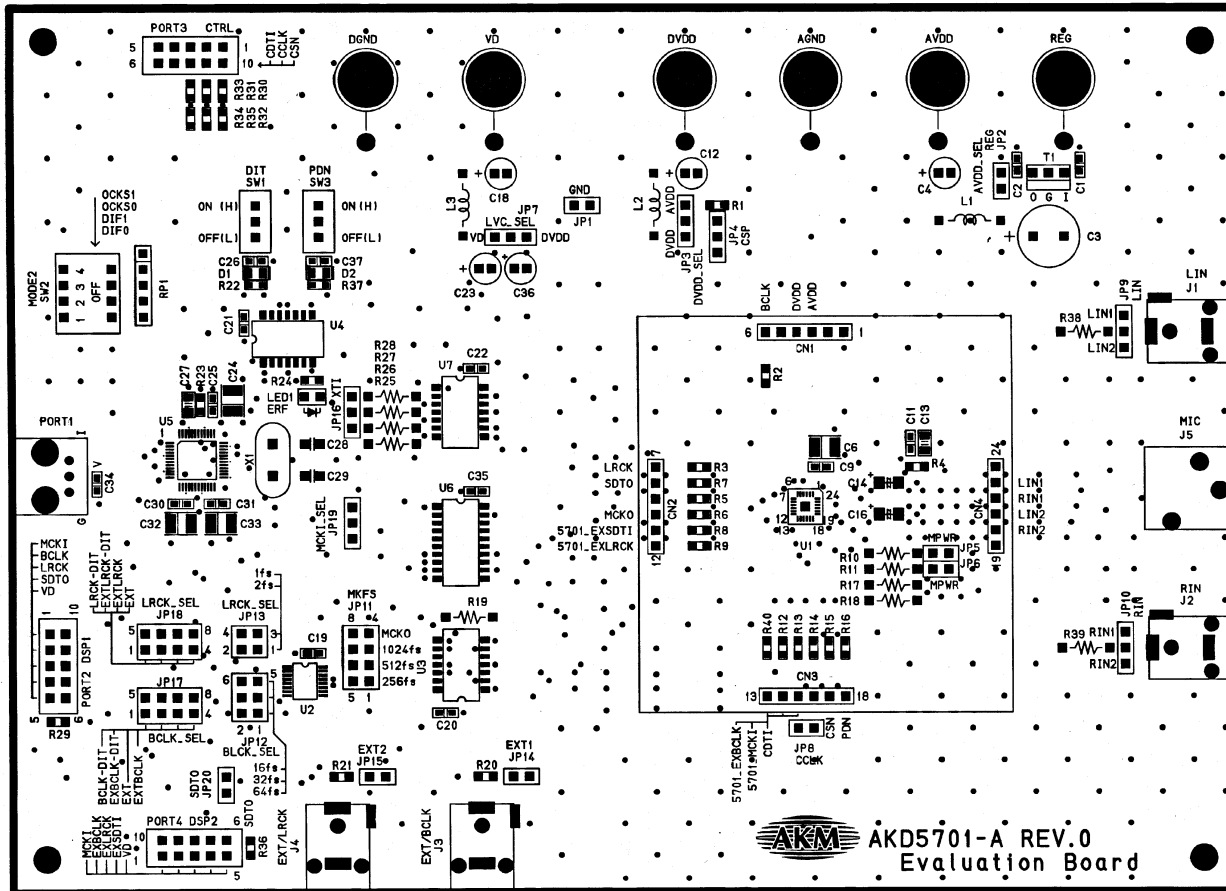

AKD5701-A L1 SILK

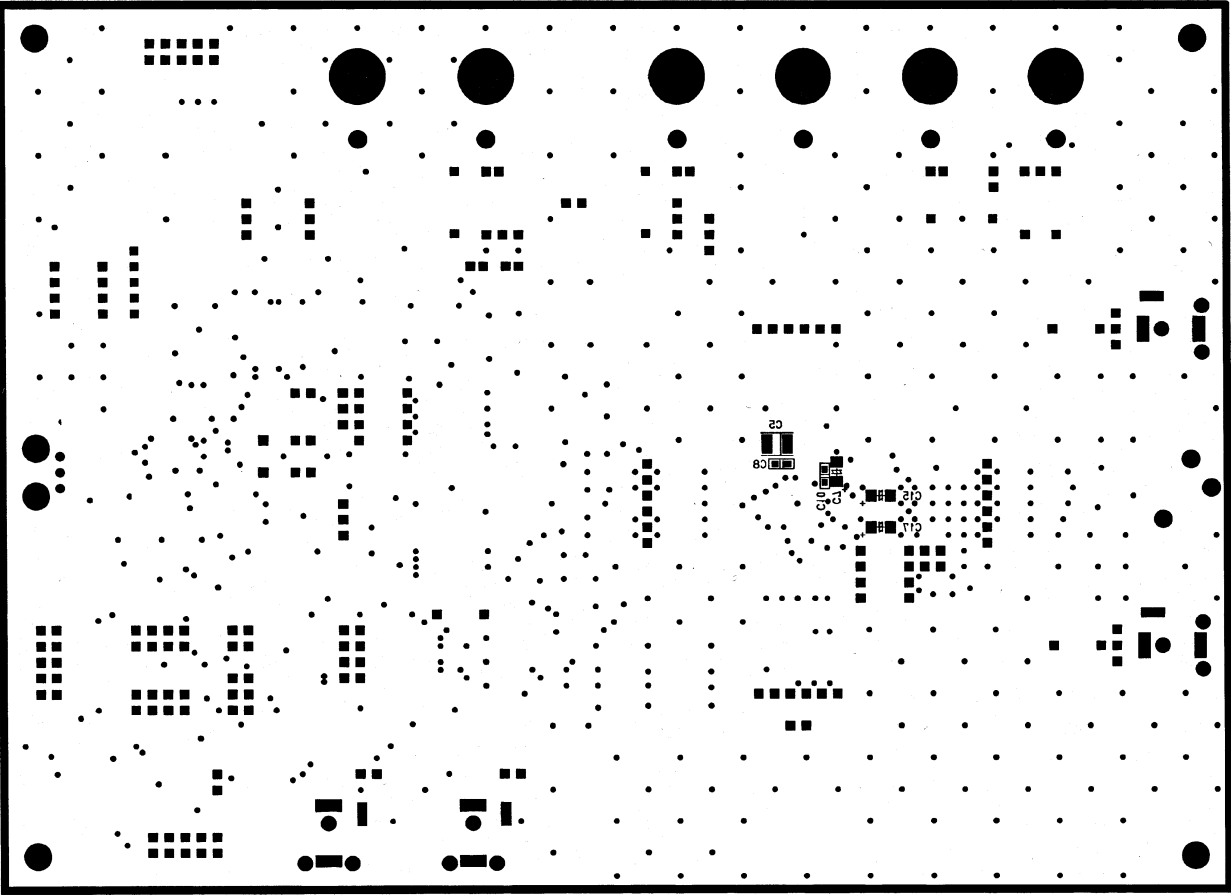

AKD2101-A LS SILK

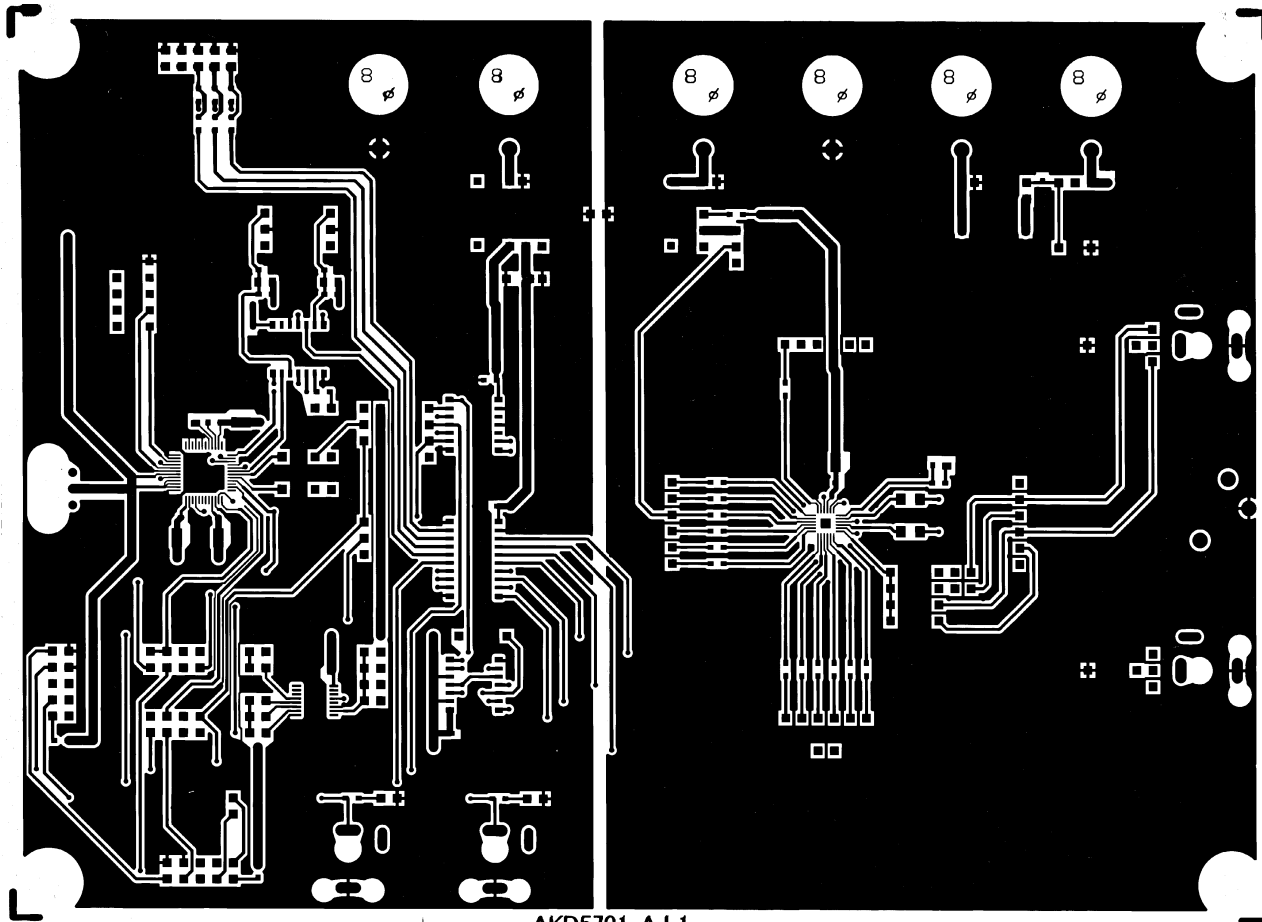

AKD5701-A L1

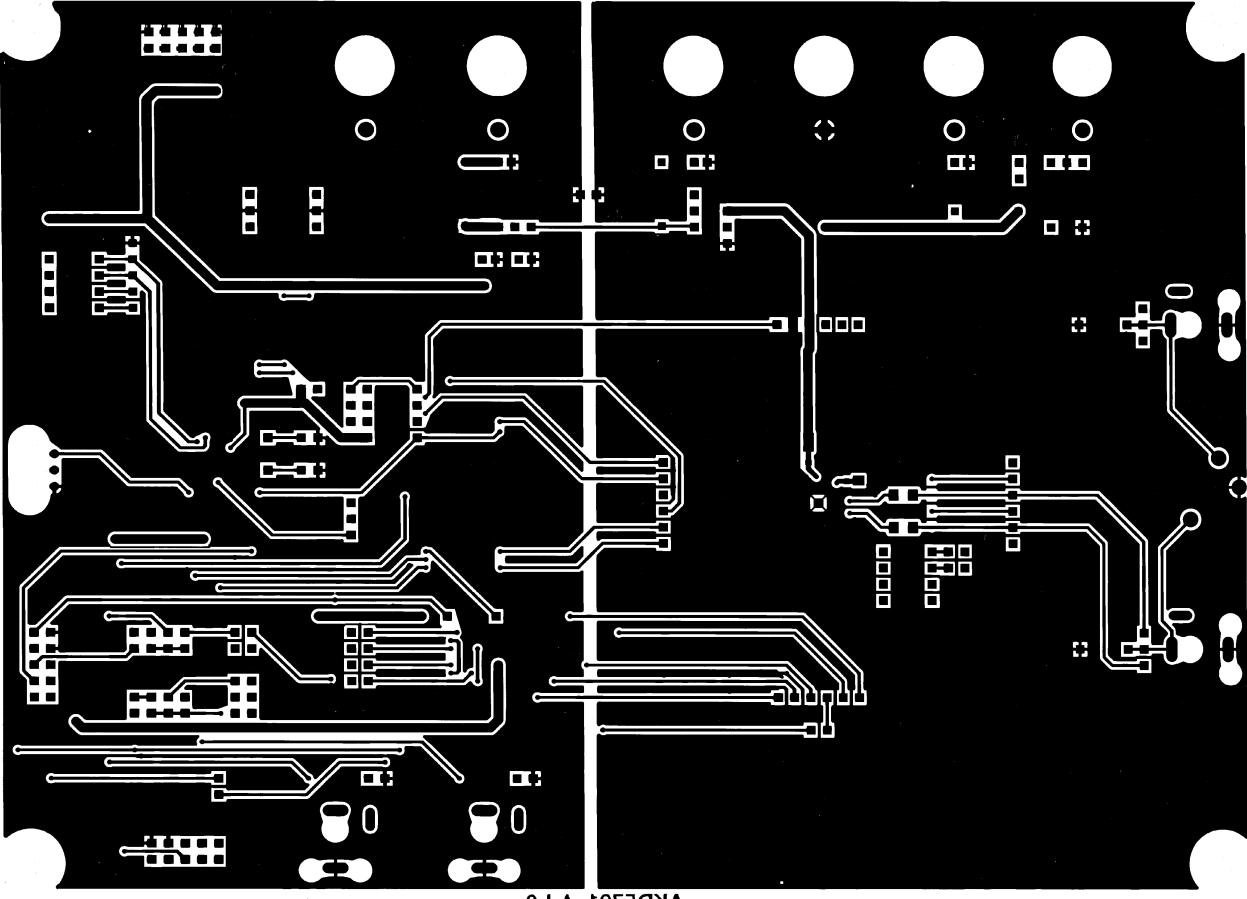

AKD2101-A LS