

Asahi Kasei Group Intellectual Property Report 2013

Organization for IP

Corporate IP, part of New Business Development in the holding company of the Asahi Kasei Group, is the organization responsible for management of intellectual property (IP) for the Group.

Corporate IP also formulates and executes IP strategy for the Group, and provides the shared infrastructure for the Group's IP functions.

Each core operating company of the Group also has its own organization for management of IP rights, including their acquisition, maintenance, and enforcement. The IP organizations of the core operating companies are staffed with liaison personnel of Corporate IP, and with concurrent positions in the core operating

companies, these personnel work to identify IP, secure IP rights, and enforce those rights in concert with each core operating company's own business strategy and R&D strategy. They also formulate IP strategies for the core operating companies and advance coordination with inventors.

Certain functions identified for reinforcement are shared by Corporate IP throughout the Group. Corporate IP also provides Group-wide services performed by the dedicated specialist personnel of its Strategic Licensing Group, Trademark Group, Technical Information Group, and Planning & Control Group.

Asahi Kasei Group Organization for IP

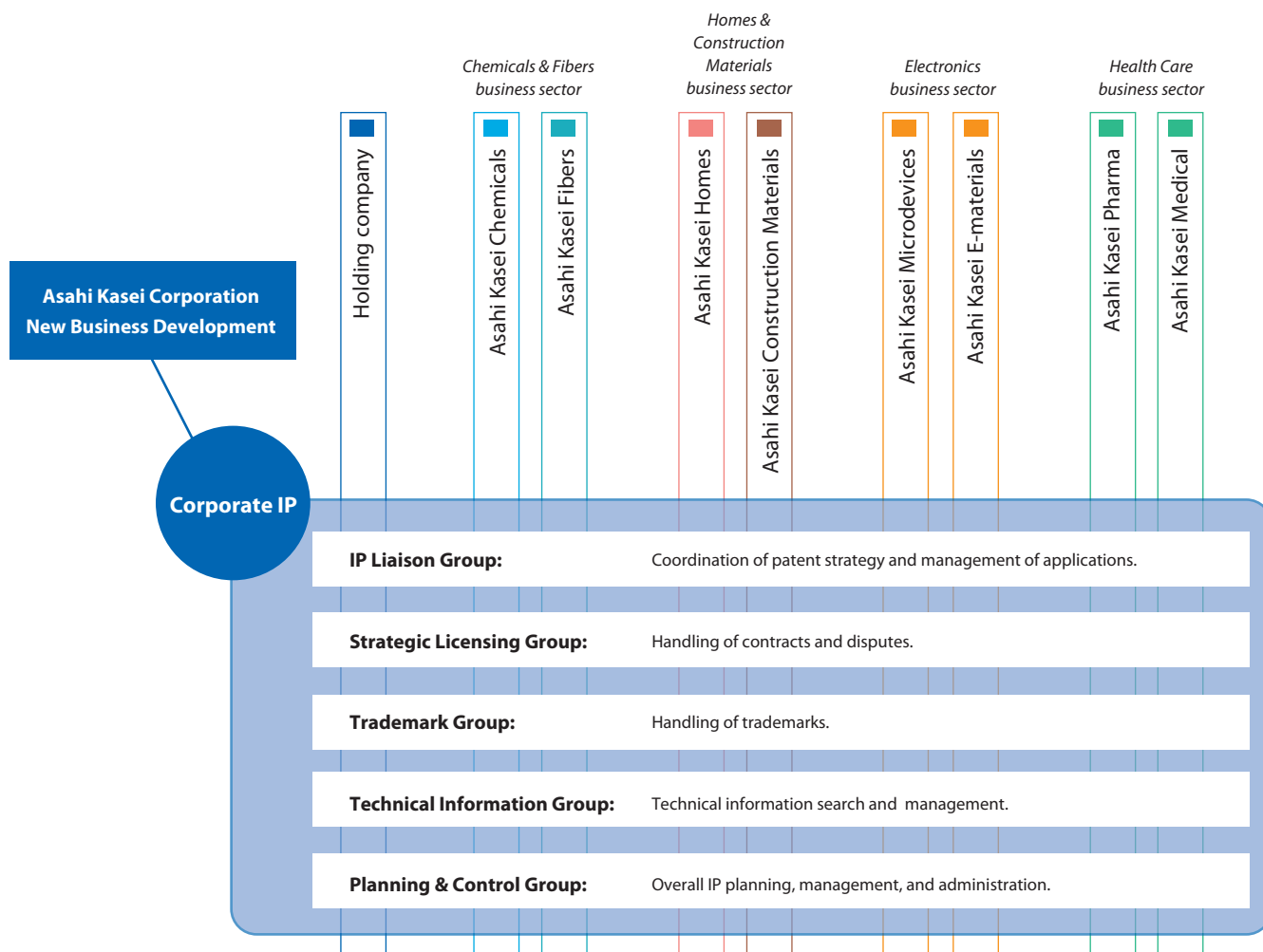

IP Strategy

Basic Policy

In the Asahi Kasei Group, the management strategy, IP strategy, and R&D strategy of each operation are integrated as one, with the creation of new businesses as an important management task. IP activities are advanced in direct connection with the management of operations to gain business advantage by the steady acquisition of IP rights from R&D results, enabling the creation of new businesses and the securement of profitability in existing businesses.

The core operating companies take the lead in formulating IP strategy for each operation in line with the relevant business characteristics. The primary focus is on strengthening existing businesses, with equal emphasis placed on the quality and the quantity of patents. Strategic licensing is performed when it is deemed an effective means to heighten the contribution of IP rights to our own business operations.

A relationship of mutual trust and reliance is fostered between the personnel working on IP and those working on R&D, as the IP and R&D functions advance in close coordination to strengthen business operations.

Thorough Patent Searching

The Asahi Kasei Group considers reliable and effective patent searching to be vital, and thorough patent searches are performed at critical phases in the process of developing IP rights. Patent searches are conducted by different personnel in correspondence with different purposes. Technology information specialists in Corporate IP conduct key searches related to subjects which significantly impact business operations. Researchers conduct primary searches themselves, which enhances their patent searching ability and heightens their motivation.

Continuous monitoring of patent information related to R&D projects for selective dissemination of information (SDI) is another focus of patent searches. These search and monitoring results are compiled into a strategic database which is utilized as described under IP Portfolio, below.

Overseas IP Strategy

The expansion of world-leading businesses is one of the main strategies of the Asahi Kasei Group's medium-term management initiative. Accordingly, Corporate IP places emphasis on the securement and utilization of firm IP rights that support global business operations, especially in the US, China, Europe, and the emerging countries. As China continues to grow in importance for our global expansion, we are also strengthening a wide range of IP activities in China. The ongoing and comprehensive reinforcement of global IP activities will continue to support further expansion of operations worldwide.

IP Portfolio

The Asahi Kasei Group maintains a strategic database (SDB) of patent information to enable strategic analysis in the management of its IP portfolio. The information contained in the SDB is used for advancement of the business operations, R&D, and IP activities.

One unique characteristic of the SDB is the inclusion of supplementary information specific to each individual patent (both in-house patents and other company patents) as related to each R&D project. The supplementary information includes a rank of importance, status of use, technology category, and countermeasures to other company patents.

Key aspects of the utilization of this SDB include 1) tracking trends in technologies, in markets, and in other companies, 2) identifying subjects for R&D, 3) clarifying the positioning of technologies and patents, including those of other companies, and 4) identifying patents which would pose an impediment to R&D and to business operations, and formulating countermeasures.

Through maintenance and utilization of the SDB, the IP Liaison Group and the Technical Information Group of Corporate IP work closely together with each R&D organization to formulate and implement countermeasures in response to other company patents as well as plans for in-house patent applications.

Strategic Database of Patent Information

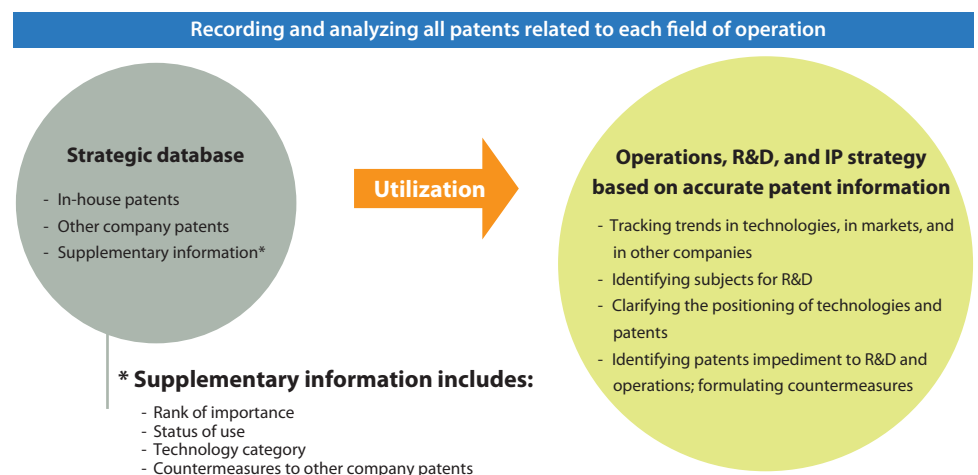

Number of IP Applications and Rights

The Asahi Kasei Group works to continuously maintain an IP portfolio that will secure market superiority in business operations. The IP portfolio is reviewed annually to determine whether to file patent applications and whether to maintain or abandon patents and applications, as well as the feasibility of licensing.

Among Japanese patents, those in practice amount to 38% (40% in the previous year) of the total. Combined with those

scheduled to come into practice, this rises to 64% (62% in the previous year). The 36% of the total which is classified as “defensive and other” includes many strategically essential patents which serve to inhibit the entry of competitors.

The number of patents held overseas is steadily rising with patent protection playing an increasingly important role for global operations.

Japanese Patent Applications

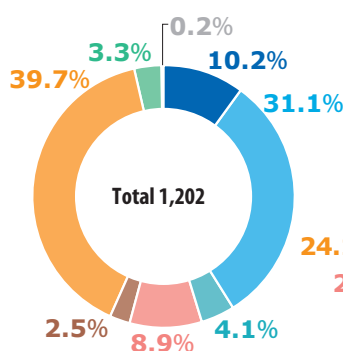

Overseas Patent Applications

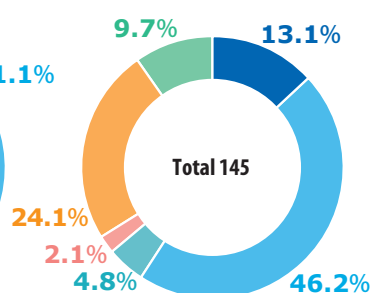

Japanese Trademark Applications

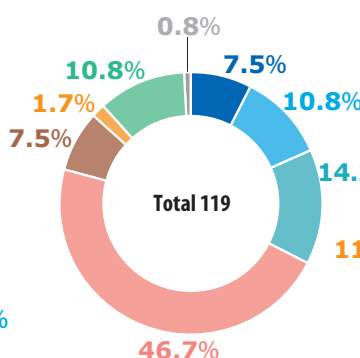

Overseas Trademark Applications

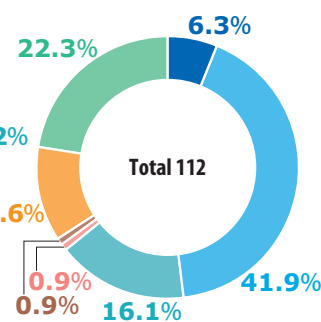

■ Holding company ■ Chemicals ■ Fibers ■ Homes ■ Construction Materials ■ Electronics ■ Health Care ■ Others

Number of Applications, by Segment

From January 1, 2012, to December 31, 2012

		Holding company	Chemicals	Fibers	Homes	Construction Materials	Electronics	Health Care	Others ¹	Total
Patents	Japanese	125	379	50	108	31	484	41	2	1,202 ²
	Overseas	19	67	7	3	0	35	14	0	145 ³
Trademarks	Japanese	9	13	17	56	9	2	13	1	119 ²
	Overseas	7	47	18	1	1	13	25	0	112

Number of IP Rights, by Segment

As of December 31, 2012

		Holding company	Chemicals	Fibers	Homes	Construction Materials	Electronics	Health Care	Others ¹	Total
Japanese Patents	In practice	42	987	187	254	137	557	109	23	2,296
	Scheduled to be in practice	201	604	143	116	41	415	46	14	1,580
	Defensive & other	155	1,016	121	121	112	544	136	3	2,208
	Total	398	2,607	451	491	290	1,516	291	40	6,040 ²
Overseas Patents	U.S.	99	532	55	0	4	237	121	8	1,056
	Europe	137	756	123	0	46	190	328	3	1,583
	Asia	136	1,469	134	0	17	475	129	5	2,365
	Other	40	215	12	0	14	26	82	0	389
	Total	412	2,972	324	0	81	928	660	16	5,388 ²
Trademarks	Japanese	224	545	1,595	485	231	127	384	41	3,630 ²
	Overseas	357	931	846	5	44	278	381	0	2,842

1 Others: Asahi Kasei Engineering Corp.

2 Not equal to sums of individual totals due to sharing of certain IP rights among more than one segment.

3 Overseas applications for a single patent family are counted as one.

Strategic IP Management

Management of IP Rights

Based on the view that IP is fundamental to obtain profit in business, the acquisition, maintenance, and enforcement of IP rights are performed in accordance with the Asahi Kasei Group Intellectual Property Management Regulations.

Once IP is identified in R&D, researchers, liaison personnel, and technology information specialists work in concert to acquire IP rights. Application procedures and the storage and management of IP information are almost fully computerized, enabling the swift exchange of information with researchers and IP law firms located around the world. We enhance close communication and coordination with IP law firms as important strategic partners in the management of IP.

Managing Trade Secrets and Preventing Unauthorized Technology Outflow

Thorough management of trade secrets and other confidential information in the Asahi Kasei Group is performed in accordance with its Secrecy Maintenance Regulations. Information in digital format is managed in accordance with Basic Regulations for Information Systems and information about individual people is managed in accordance with the Guideline for Personal Information Management. The Asahi Kasei Group implements strict measures to prevent unauthorized or unintentional outflow of technological information and know-how in accordance with its basic policy and management standards for prevention of technology outflow. The Asahi Kasei Group also applies internal guidelines summarizing related precautions to take when entering business overseas as well as procedures to ensure the preservation of prior-use rights in China.

To raise awareness and understanding regarding such issues among personnel, a wide range of education and training measures are performed.

Corporate Brand Strategy

The corporate brand “Asahi Kasei” has been registered in 76 countries, and the current Group Logo combining “Asahi” with “KASEI” in upper case has been used since 2007. The Group Logo is an expression of innovation, and is designed to promote correct pronunciation. In the growing market of China, Chinese characters for “asahi” and “kasei” are added to the logo to enhance recognition of the Asahi Kasei brand.

The Group Logo and Company Logotype represent the identity and reliability of the Asahi Kasei Group. We have established a Group Emblems Guideline to ensure unified usage around the world within a defined style, format, and application range. The unified global Asahi Kasei Group identity is further reinforced by our

Group Logo

AsahiKASEI

Chinese Group Logo

AsahiKASEI
旭化成

Information Disclosure Policy and Information Disclosure Regulation requiring compliance with the Group Emblems Guideline. To confirm adherence to our established brand management standards, Corporate Communications reviews the content of exhibits, advertisements, and external announcements before they are made public.

Incentives for Innovation

Incentives for employee innovation include lump-sum rewards upon application for and grant of patents, and special rewards for inventors who make exceptional contributions to business operations. In April 2005, we made substantial revision to our invention reward system eliminating any theoretical limits on rewards and rewarding inventors when a patented invention is commercialized. Such incentives serve to focus the minds of our young researchers on the objective of obtaining IP rights and further promote inventions which result in commercialization. For researchers based outside of Japan, we have separate incentive systems tailored to the law and customs of each country. These systems are continuously reviewed, with further revisions made as appropriate in accordance with the times and as deemed fair and effective to foster greater motivation to obtain IP rights which make valuable contributions to operations in line with the IP strategy of each business.

System to Reward Innovation (in Japan)

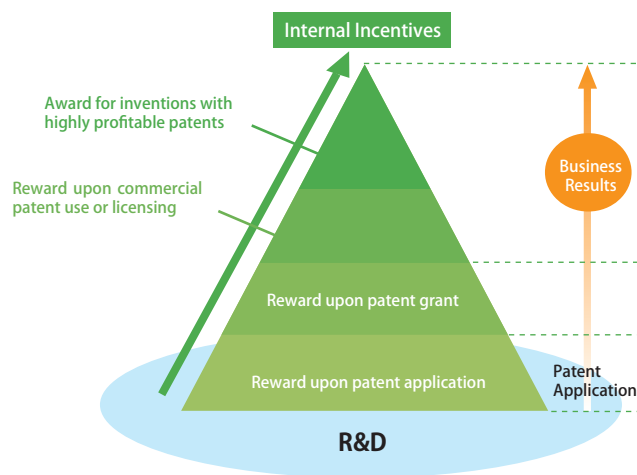

Human Resource Development

Recognizing human resources as an essential key to the execution of its IP strategy, the Asahi Kasei Group implements a comprehensive range of measures for the education and training of personnel in matters related to IP. The systematic program begins with orientation for new employees, and includes uniform training sessions for technical personnel and for marketing personnel throughout the Asahi Kasei Group. In addition, “e-learning” programs are made available on the corporate intranet to enable personnel to further enhance their practical knowledge related to IP rights.

Dr. Akira Yoshino awarded the Global Energy Prize

Asahi Kasei Fellow Dr. Akira Yoshino received the 2013 Global Energy Prize in recognition of his invention of the lithium-ion battery (LIB), which is an essential element for mobile electronic devices, electric vehicles and hybrid electric vehicles.

The Global Energy Prize

Established in Russia in 2002, the Global Energy Prize is one of the world's most respected awards in energy science awarding outstanding energy achievements and innovations. The winners of the 11th Global Energy Prize were selected by the International Award Committee from 82 candidates who were nominated by eminent scientists from all over the world. The degree to which a development contributes to the benefit of humanity is a key driver in deciding the recipient of the Prize. Since 2002, the prize has been given to 29 people from 9 countries.

LIB Technology

In the 1980s, demand for a high-capacity, small, and lightweight rechargeable battery rose together with the development of portable electronic devices such as video cameras, laptop computers, and mobile phones. In 1985, Dr. Yoshino invented a completely new combination of carbon as the negative electrode and LiCoO_2 (lithium cobalt oxide) as the positive electrode, the fundamental technology for the LIB. The LIB met the need for a small and lightweight rechargeable battery which could not be achieved with other rechargeable battery technologies such as nickel-cadmium and lead-acid.

The LIB became into practical use in the beginning of the 1990s. At present, a wide variety of electronic devices, such as mobile phones and laptop computers rely on the LIB. Its use is growing in emerging applications such as electric vehicles.



Dr. Yoshino (right) with his trophy at the award ceremony

Structure of the LIB

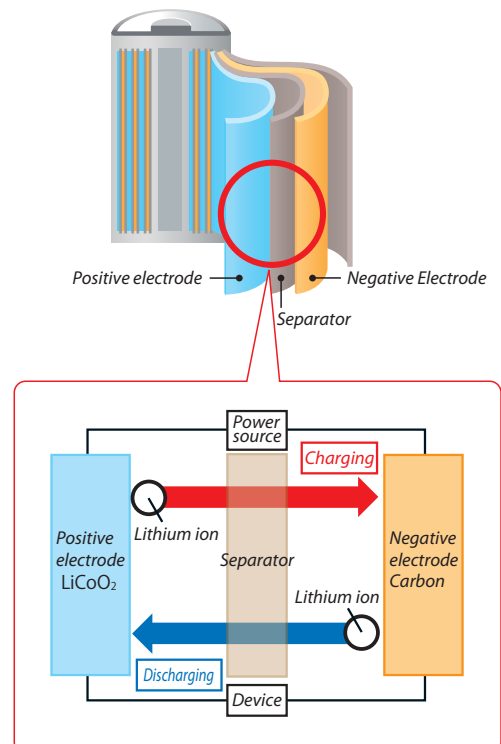

Major External Commendations

Fiscal Year	Commendation	Organization	Title
2013	The Global Energy Prize	Global Energy Partnership	Invention of Rechargeable Lithium-Ion Battery, which is An Essential Element for Mobile Electronic Devices, Electric Vehicles and Hybrid Electric Vehicles
2012	National Commendation for Invention The Imperial Invention Prize	Japan Institute of Invention and Innovation	Automatic Adjustment Technology of Electronic Compass
	The Okochi Memorial Technology Prize	Okochi Memorial Foundation	Development of a Genetically-Engineered Thrombomodulin Agent for the Treatment of Disseminated Intravascular Coagulation (DIC)
2011	National Commendation for Invention The Invention Prize	Japan Institute of Invention and Innovation	Polysulfone-Membrane Hemodialyzer
2010	The Commendation for Science and Technology by the Minister of Education, Culture, Sports, Science and Technology	Ministry of Education, Culture, Sports, Science and Technology	Comprehensive Research on Thrombomodulin as An Antithrombotic Molecule on Vascular Endothelial Cell
2009	National Commendation for Invention The Invention Prize	Japan Institute of Invention and Innovation	Non-Fluorocarbon Gases High-Performance Phenolic Resin Foam
	The Okochi Memorial Production Prize	Okochi Memorial Foundation	Development of Separator for High-Safety and High-Performance Lithium-Ion Secondary Batteries
2008	Medal with Purple Ribbon	Government of Japan	Development of Novel Process for Polycarbonate Production from CO ₂ without Using Phosgene
	National Commendation for Invention The Invention Prize	Japan Institute of Invention and Innovation	The Catalyst for the 2nd Stage Reaction in the Direct Methyl-Esterification to Produce MMA
	The CSJ Award for Technical Development	The Chemical Society of Japan	Direct Methyl Esterification Route for MMA – Development of Its Catalytic Chemistry and Process Engineering –
	The Award of the Society of Polymer Science, Japan	The Society of Polymer Science, Japan	Development of Microporous PE Film which Contributed to Dissemination and Innovation of Lithium-Ion Battery
2007	The Commendation for Science and Technology by the Minister of Education, Culture, Sports, Science and Technology	Ministry of Education, Culture, Sports, Science and Technology	Development of Novel Antileukemic Drug of N4-Behenoyl Cytosine Arabinoside
	The Commendation for Science and Technology by the Minister of Education, Culture, Sports, Science and Technology	Ministry of Education, Culture, Sports, Science and Technology	Development of Novel Process for Polycarbonate Production from CO ₂ without Using Phosgene

Local Commendations for Invention (Japan Institute of Invention and Innovation)

Fiscal Year	Commendation	Area	Title
2012	The Encouragement for Invention Prize	Kanto	Ion-exchange Membrane
	The Prize of Okayama Prefectural Governor	Chugoku	Innovative Catalyst for Production of MMA by Direct Methyl-Esterification
2011	The Encouragement for Invention Prize	Kanto	Housing Design Method Using Sunlight Simulation
2010	The Encouragement for Invention Prize Chairman of Japan Patent Attorneys Association	Kyushu	Automatic Adjustment Technology of Electronic Compass
	The Encouragement for Invention Prize	Chubu	Surface-Grooving Method for ALC Wall Panels
2009	The Encouragement Prize of the Commissioner of Japan Patent Office	Kanto	Development of Material for Battery Case for Use in Hybrid Electric Vehicles
	The Encouragement Prize of the Chairman of HATSUMEI KYOKAI (JIII)	Kyushu	Polysulfone-Membrane Hemodialyzer
	The Encouragement Prize of the Chairman of HATSUMEI KYOKAI (JIII)	Kinki	Development of Comfortable Innerwear Using Composite Yarn
	The Encouragement for Invention Prize	Chugoku	Method of Producing Aromatic Hydrocarbons from Light Hydrocarbons
	The Encouragement for Invention Prize	Kanto	Mechanical Coupling for Steel Pipe Pile
	The Encouragement for Invention Prize	Kanto	Surface-Patterned Panels for Exterior Walls